

# USB 2.0 10 / 20 Port Charge Hub User's Manual

## USBG-10XU1 / USBG-20XU1



USBG-10XU1



USBG-20XU1





## Introduction

USBG-10XU1 / USBG-20XU1 is 10 / 20-port USB Hub with Charger, a smart solution for charging or sync of several iPads, iPhones iPods and USB charging devices operating simultaneously. This is a perfect tool to eliminate the jumble of wires and chargers and also is ideal for large capacity USB station in-house for automated duplication tasks. Places such as school's class room, businesses conference or meeting in organizations.

## Features

- Charges or syncs up to 10 / 20 iPads, iPods, iPhones or other USB-charged in charge mode devices, providing each USB port with the optimum charge level for each device.
- Will also charge virtually any other device that can be charged through a powered USB port.
- Supports High Speed 480Mbps, full speed 12Mbps and low speed 1.5Mbps operation
- Fully compatible with all USB compliant device
- Ten (10) or Twenty (20) Hi-Speed USB 2.0 downstream ports
- Over-current detection and protection
- Surge & ESD Protection
- Extends up to optimum 40 USB devices by connecting cascade port with another USB 2.0 charge hub(s); to see notes under specification.
- Supports Windows OS : 98SE / ME / 2000 / XP / Vista / 7 / 8 / 8.1 , Mac OS 8.6 / 9.x / 10.x or higher
- Rack mountable.

## Specification

Model No.	USBG-10XU1	USBG-20XU1
Chip	Terminus	
USB Specification	USB 1.1 / 2.0 compliant	
Connector Upstream	USB B Female	
Connector Downstream	USB A Female x 10	USB A Female x 20
Connector Cascade	USB A Female	
LED Charge Mode	Red Color x 10	Red Color x 20
Power Mode	External power adapter	
Power consumption	24VDC 6.25A	
LED SYNC Mode	Orange Color x 10	Orange Color x 20
Cable Length	1.8m	
Speed	480 / 12 / 1.5 Mbps	
Current per Port	5VDC 2100 mA	5VDC 1100 mA
Dimension (L x W x H)	268 x 102 x 40 mm	
Housing	Metal	

## Cautions

1. End user may extend another unit of USB 2.0 10 / 20 port charge hub. (It allows connecting or charging maximum up to 20 / 40 USB devices simultaneously.)
2. The specific cable for iPad, tablet isn't included in package accessory. Please check with your distributor regarding of using appropriate cable.
3. Beware that iOS update cannot be performed simultaneously when the unit is charging for USB devices.



4. If user connects with two units, the 2nd unit may not be detected by some computers which have built in USB 3.0 hub.

## Package Contents

1. USB 2.0 Charge Hub
2. 24VDC 6.25A Power adaptor with power cord
3. USB 2.0 A/M to B/M cable
4. Mounting brackets with screws
5. User manual

## Physical Diagram

<Front View>

3 – LED Indicators

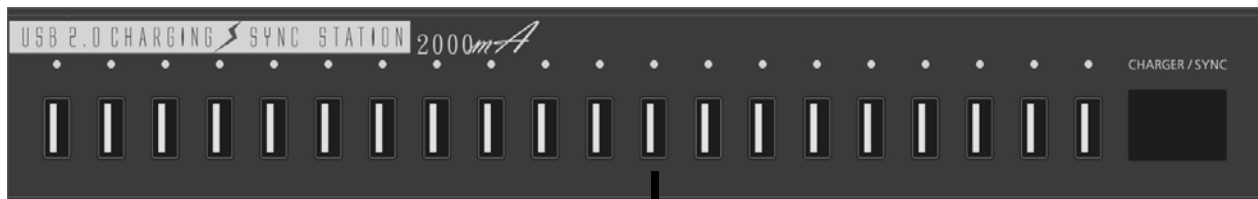

1 – USB Ports (Hub)

2 – Charger / SYNC Switch

<Rear view>

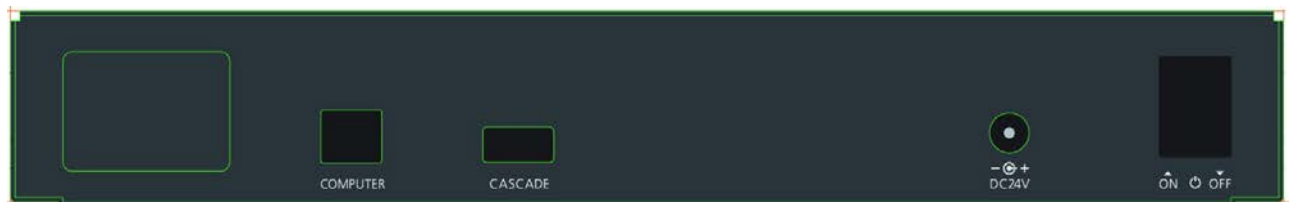

7 – USB Port for computer

6 – USB Port for extending 2<sup>nd</sup> unit

5 – Power Jack

4 – Power Switch

### 1. USB Ports (Hub) - Allows connecting iPad, tablet or USB devices

- Beware that this unit does not require a host computer connected to the hub for it to charge compatible devices.
- This unit does not contain accessory set of cables for iPad, tablet. Please check with your distributor regarding of using appropriate cable.

### 2. CHARGER / SYNC Switch

- Allows to switch charging or sync mode under connecting with iPad, tablet.
- Charging mode indicators light on): to charge the objective USB devices.





- Sync mode indicators light off) : to synchronize data from computer to objective USB devices, but not allowed charging.

In order to prevent from damaged data that may cause by unsuitable operation, beware of below issues when user is switching from sync mode to charging mode:

- User should not switch until the objective iPad or tablet OS is updated completely.
- Do not switch until the objective USB connections are removed safely from host computer.

Please check the user manual of USB devices for appropriate removing method.

### 3. LED Indicators

- LED lights up: indicates which tablet or USB device is connected successfully.
- The LED may not light up when the unit is connecting with some specific USB devices, but it is still working on charging or synchronizing.

### 4. Power switch

User may switch power to on / off.

### 5. Power jack

To use with power adaptor provided.

### 6. USB port for extending 2nd unit

It is available to connect with another unit for extending purpose.

### 7. USB port for computer

It is available to connect with host computer by USB cable.

## Rack Mounting

To install, attach the mounting brackets to the unit's side panels (one on each side) and secure them with the screws provided.

**(1)** Use the mounting brackets and screws onto rack.



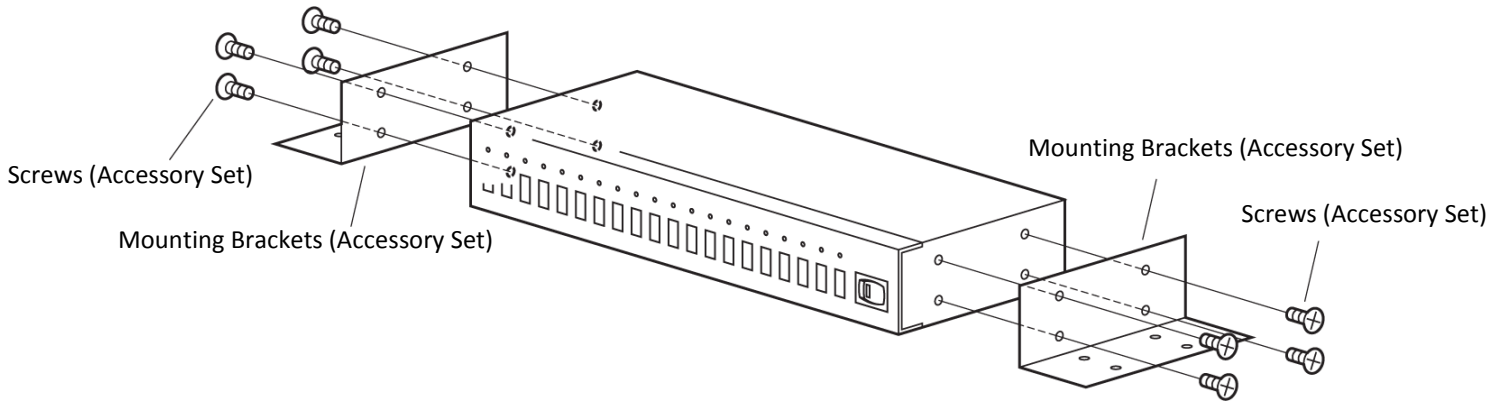

(2) User may install on the applicable cabinet, rack environments.

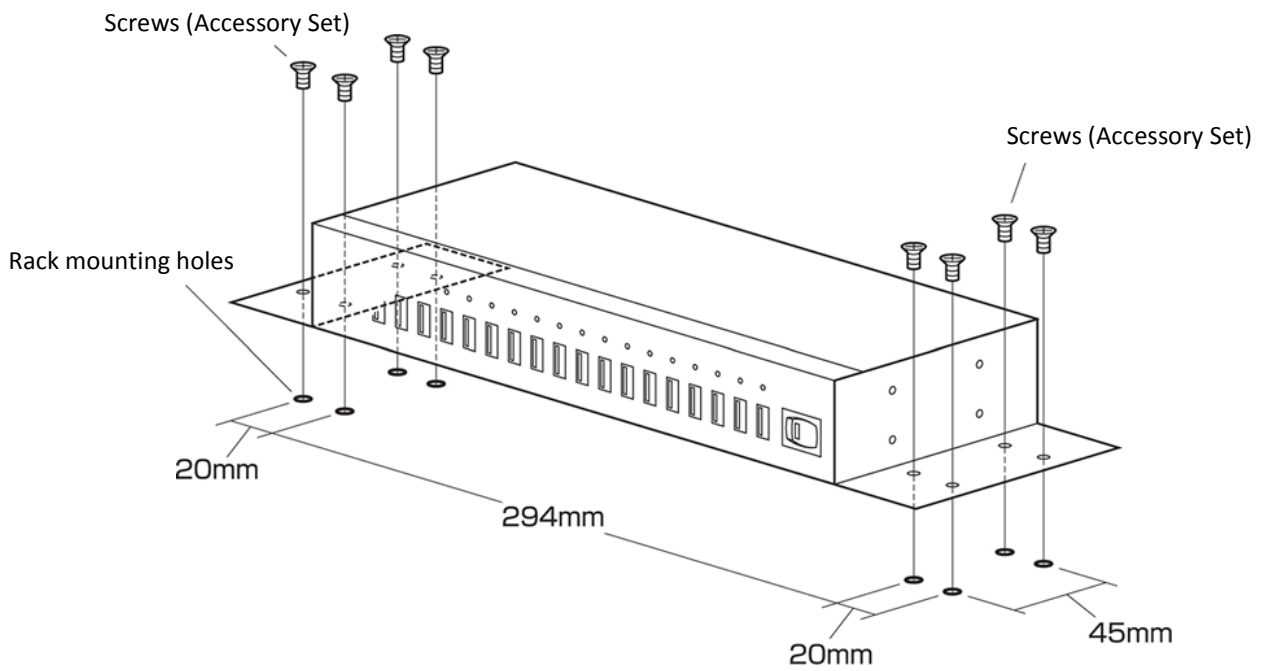

## Connection

(1) To turn off the power switch.

<Rear Panel>

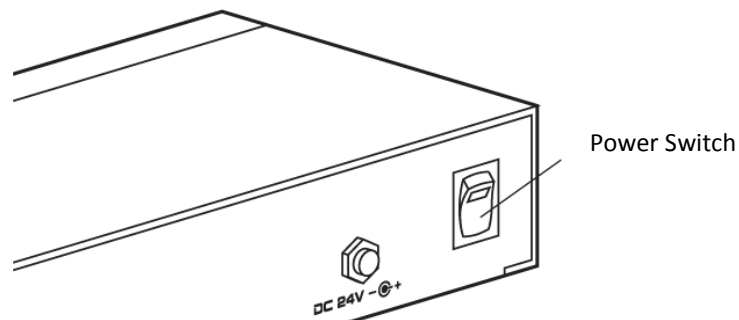

(2) Plug the power adaptor to the unit's power jack.

The power jack is threaded with nut, so user may put power DC plug into the power jack without loosening.

(3) Put the plug of power adaptor into the socket of wall mounted.

<Rear Panel>

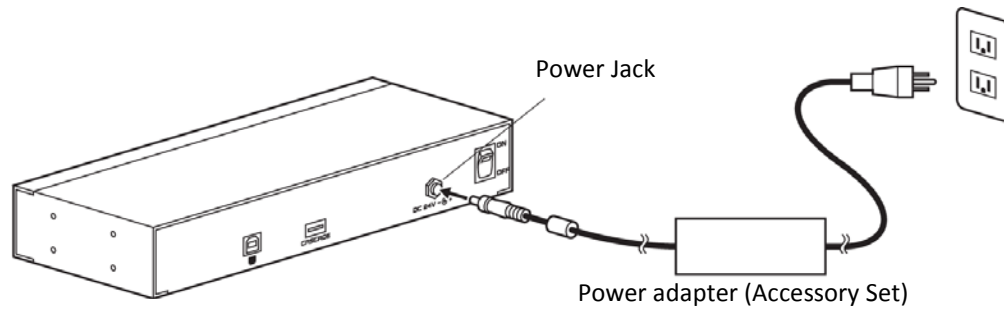

(4) Turn on the power switch.

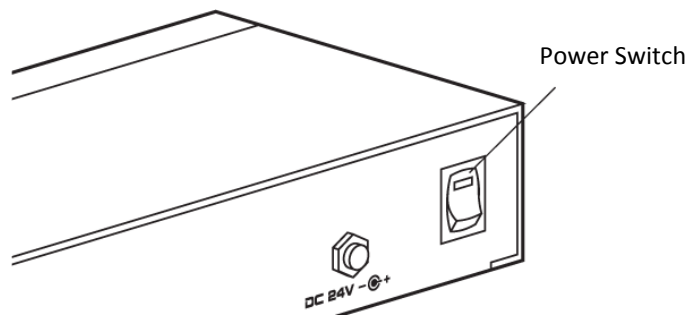

(5) Using the USB A to B cable provided and connects the USB B end on the unit.

(6) Using the USB A end and connects on your host computer.

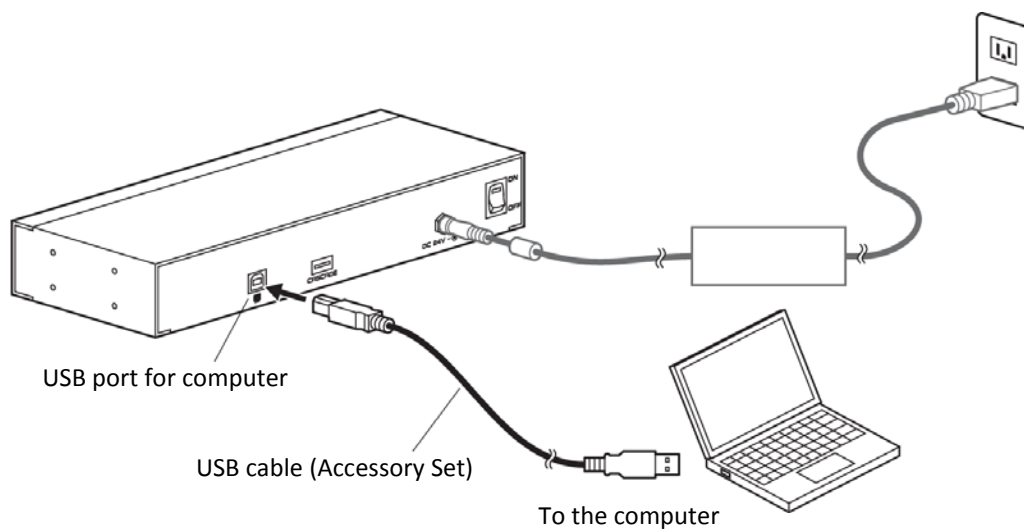

(7) In according to the previous instruction of connection with host computer, and connects host computer with the unit.

<Rear Panel>

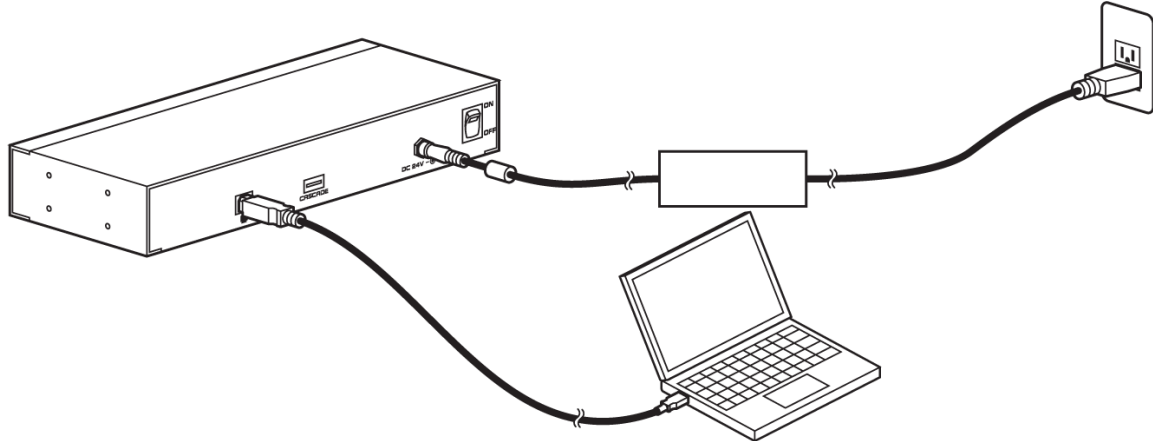

(8) To use USB cable and connects with tablet or USB devices to the USB ports (Front Panel).

<Front Panel>

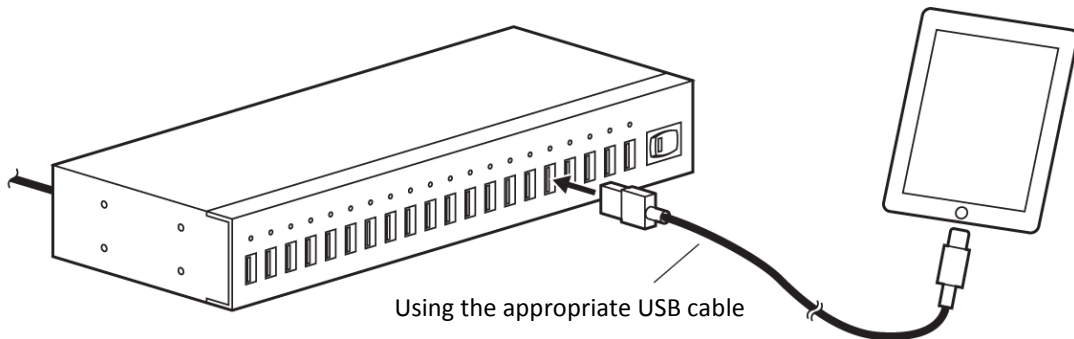

## Charging mode

Please follow below ways for charging USB devices.

(1) In according to the previous instruction of connection with host computer, and connects host computer with the unit.

(2) Turn the switch of CHARGER / SYNC to [CHARGER], and LED lights up.

<Front Panel>

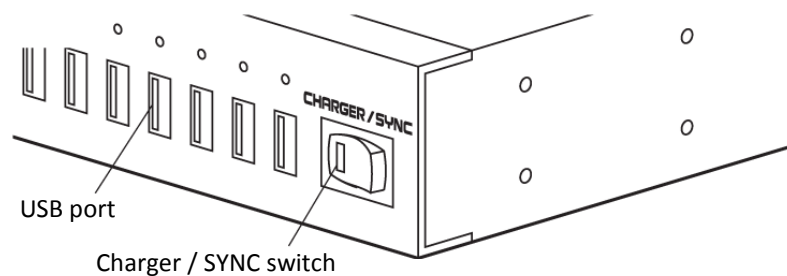

**(3)** Connect your USB devices to the USB ports on the hub.

- This unit does not contain accessory set of cables for iPad, tablet. Please check with your distributor regarding of using appropriate cable.
- The LED may not light up even the unit can charge the iPad, tablet that is discharged completely. User may charge for a while and disconnect. Try to re-connect and charge again.

In order to prevent from damaged data that may cause by unsuitable operation, beware of below issues when user is switching from sync mode to charging mode:

- User should not switch until the objective iPad or tablet OS is updated completely.
- Do not switch until the objective USB connections are removed safely from host computer.

Please check with user manual of USB devices for appropriate removing method.

## Sync mode

Please follow below ways for synchronizing.

**(1)** In according to the previous instruction of connection with host computer, and connects host computer with the unit.

**(2)** Turn the switch of CHARGER / SYNC to [SYNC] , and LED lights off.

<Front Panel>

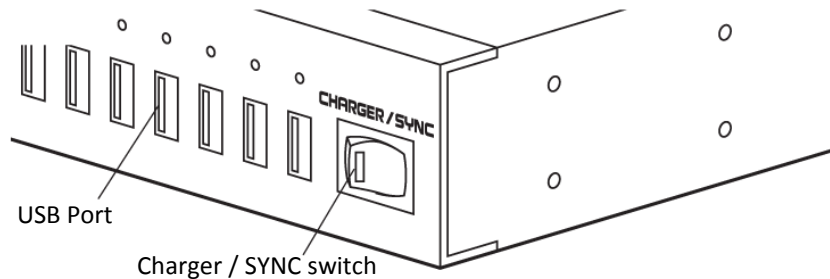

### [For host computer configuring iTunes]

- Please create a library folder on host computer for synchronizing and transfers data to iPad.
- Recommends automatic updates in your iTunes preferences (to avoid interference with automatic syncing). Please check for updates manually to keep your software up to date.

### [For iPad, tablet configuring]

- Ensure each iPad, tablet has been charged completely at first if the objective iPad, tablet is new goods.
- Please use the unit to synchronize iPad, tablet one after another, and configure at same way. (Login name, ID, the data you want to synchronize etc.)
- The user may adjust the brightness of screen when you are using the unit to synchronize iPad.
- When the user may be requested by iTunes to configure manually, you will have to copy the configuration manually for each iPad.





**[For host computer connection & sync]**

- Connect iPad, tablet to the USB ports of front panel if each iPad, tablet is configured completely.
- This unit does not contain accessory set of cables for iPad, tablet. It is especially important to use appropriate cables (USB-A to device-specific connector) provided by the device manufacturer.
- Get started synchronizing automatically once you connect the unit.
- It may take a little while for this unit to recognize and sync. Please do not stop by the way once the unit starts synchronizing.
- This unit may not perform sync with charging simultaneously.

**[For iOS update]**

- User may not perform the iPad update when iPad is connected. You must update iOS on iPad one after another.

**Daisychain (Cascade) connection**

This unit can extend another unit for daisychain (Cascade) connection, the 2nd unit can sync simultaneously as well.

- Maximum 2 units can be connected. (It allows connecting or charging maximum up to 20/40 USB devices simultaneously.)
- If user connects with two units, the 2nd unit may not be detected by some computers which have built in USB 3.0 hub.

**(1)** In according to the previous instruction of connection with host computer, and connects host computer with the 1st unit.

<Rear Panel>

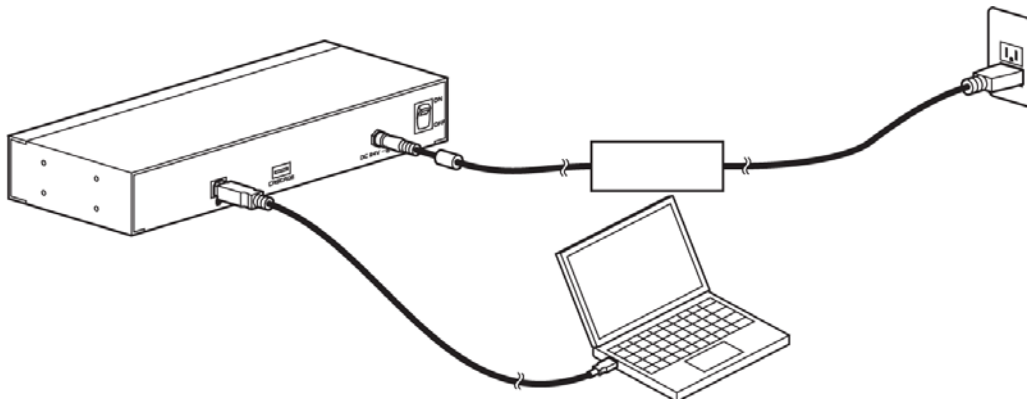

**(2)** Turn off the power switch of the 2nd unit.

<Rear Panel>

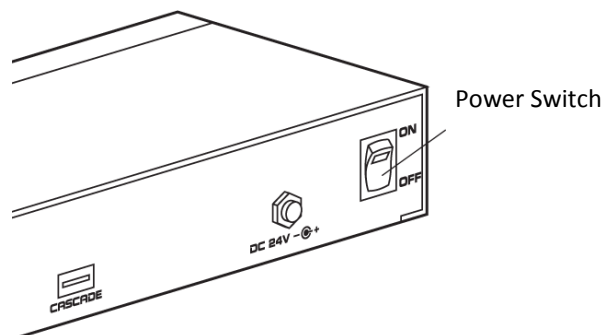

**(3)** Plug the power adaptor to the power jack of the 2nd unit.

- The power jack is threaded with nut, so user may fix power DC plug into the power jack without loosening.

**(4)** Put the plug of power adaptor into the socket of wall mounted.

<Rear Panel>

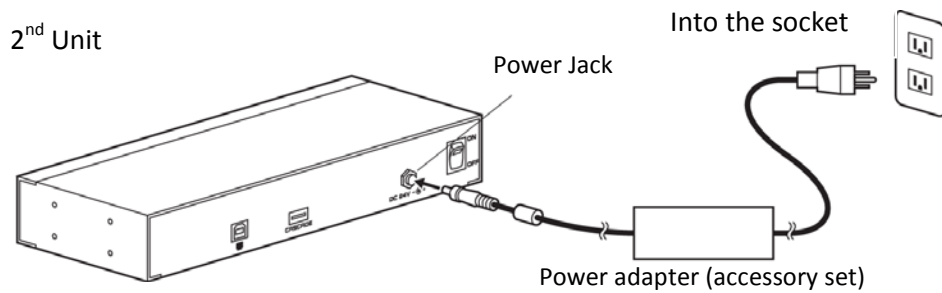

**(5)** Turn on the power switch of the 2nd unit.

<Rear Panel>

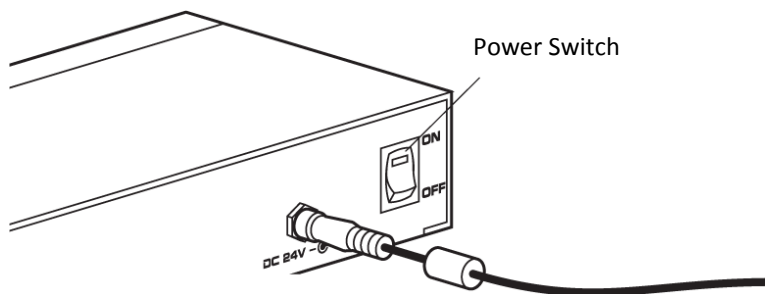

**(6)** Use the USB cable provided and connects both USB ports of the 1st and 2nd units.

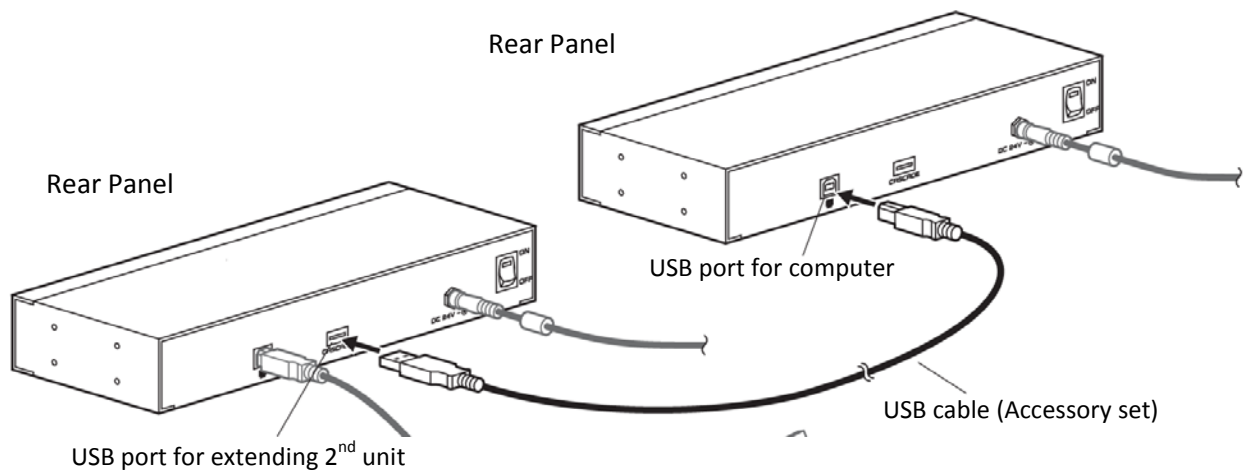

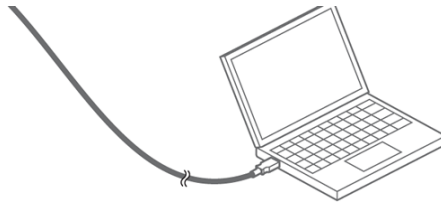

**Note :**

- Maximum 2 units can be connected.
- It allows connecting or charging maximum up to 20 / 40 USB devices simultaneously.



## Regulatory Compliance

### Disclaimer

Information in this document is subject to change without notice. The manufacturer does not make any representations or warranties (implied or otherwise) regarding the accuracy and completeness of this document and shall in no event be liable for any loss of profit or any other commercial damage, including but not limited to special, incidental, consequential, or other damages.

No part of this document may be reproduced or transmitted in any form by any means, electronic or mechanical, including photocopying, recording or information recording and retrieval systems without the express written permission of the manufacturer.

All brand names and product names used in this document are trademarks, or registered trademarks of their respective holders.

## ***CE/FCC & Recycling Information***

---

### ***CE Certification***

This equipment complies with the requirements relating to Electromagnetic Compatibility Standards EN55022/EN55024 and the further Standards cited therein. It must be used with shielded cables only. It has been manufactured under the scope of RoHS compliance.

### ***FCC Certification***

This equipment has been tested and found to comply with the limits for a Class B digital device, pursuant to part 15 of the FCC Rules. These limits are designed to provide reasonable protection against harmful interference in a residential installation. You are cautioned that changes or modification not expressly approved by the party responsible for compliance could void your authority to operate the equipment.

This device complies with part 15 of the FCC Rules.

Operation is subject to the following two conditions:

1. This device may not cause harmful interference, and
2. This device must accept any interference received, including interference that may cause undesired operation



### ***WEEE (Waste of Electrical and Electronic Equipment), Recycling of Electronic Products***

In 2006 the European Union introduced regulations (WEEE) for the collection and recycling of all waste electrical and electronic equipment. It is no longer allowable to simply throw away electrical and electronic equipment. Instead, these products must enter the recycling process.

Each individual EU member state has implemented the WEEE regulations into national law in slightly different ways. Please follow your national law when you want to dispose of any electrical or electronic products. More details can be obtained from your national WEEE recycling agency.

