

PCIEMODBOX232 RS232 to PCI Module Box Introduction

This high performance PCI (or PCIe) RS232/422/485 Combo Expansion Module product includes an expansion module box, a PCI (or PCIe) Host Adapter and a DB44 cable. It supports 8 serial ports which can be set in any combinations of RS232, RS422, RS485-2W, or RS485-4W modes. Its 256-byte-FIFO UART based serial ports are fully 16C550 UART compatible with most of the RS232C, RS422 and RS485 devices available from the market.



Features

- Supports PCI or PCIe with Corresponding PCI and PCIe Host Adapters
- Powered by the DB44 Host cable, no AC Power Adapter Required
- Supports 8 RS232/422/485 Combo Serial Ports
- Supports RS232 over Standard DB9 male Connectors
- Supports RS422/485 over 7-pin Terminal Blocks
- Supports 4-wire RS422/485 and 2-wire RS485 Modes
- Supports RS485 Auto Transceiver Turn Around by Unique Featured ATTA™ Hardware
- 256-byte deep FIFO per transmitter and receivers
- Supports Low Profile Form Factor with Optional Low Profile Bracket
- Supports Baud Rate up to 921.6Kpbs
- Optional Model: 2,500Vrms Isolated and 15KV ESD Surge Protection
- Supports Win2000, XP, 2003, 2008, Vista, Win 7, 8 and Linux

Packing List

Before installing this product, please make sure the following accessories are well packed in the box :

- Metal Expansion Module Box 1
- Wall Mounting Brackets x 4 and Screws x 8
- Add-in PCI (or PCIe) Host Card x 1
- DB44 Expansion Cable x 1
- Driver CD × 1
- This Installation Guide × 1 (Available on disc)



PCIe (PCI Express):

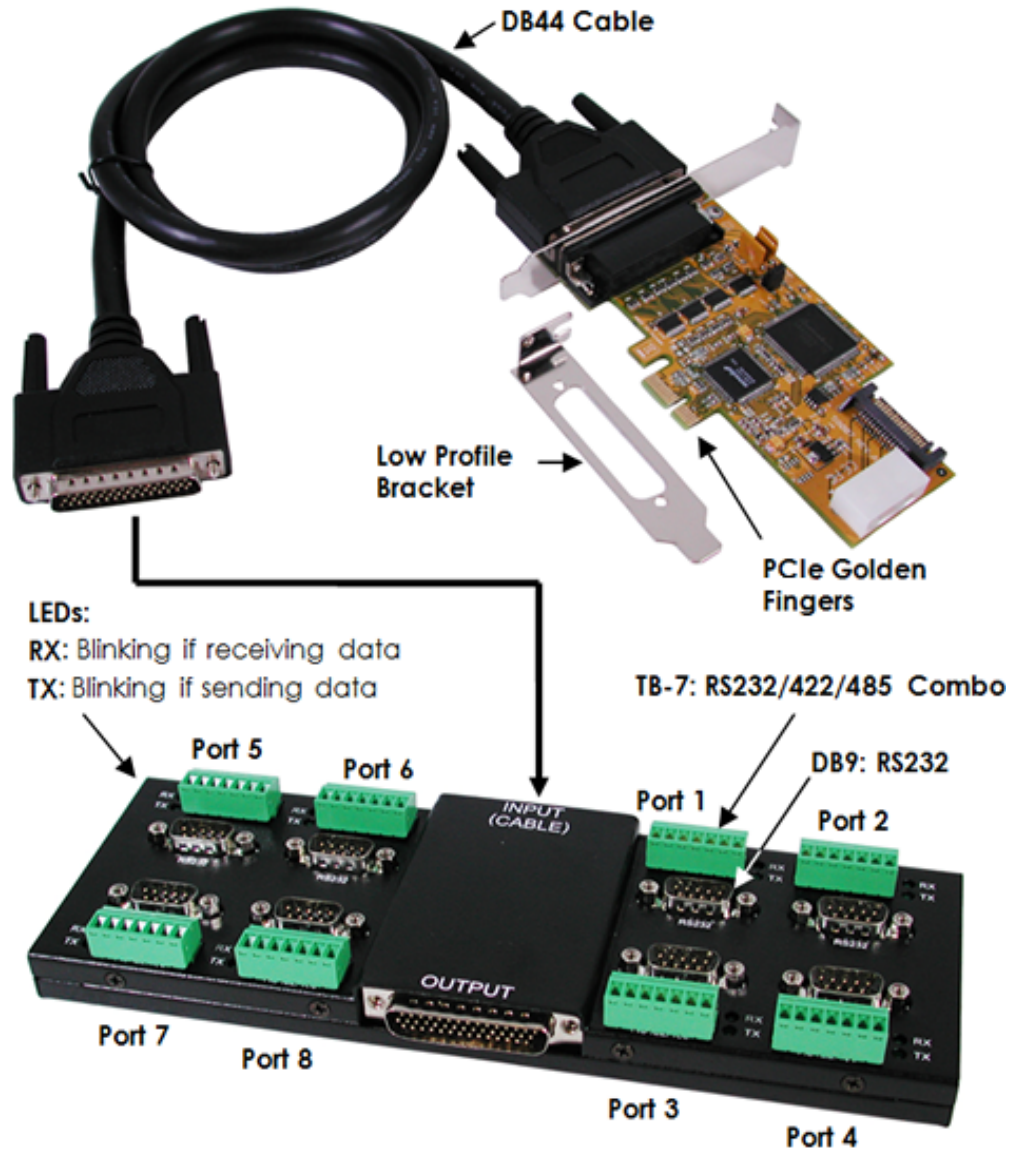

Mounting Kit:

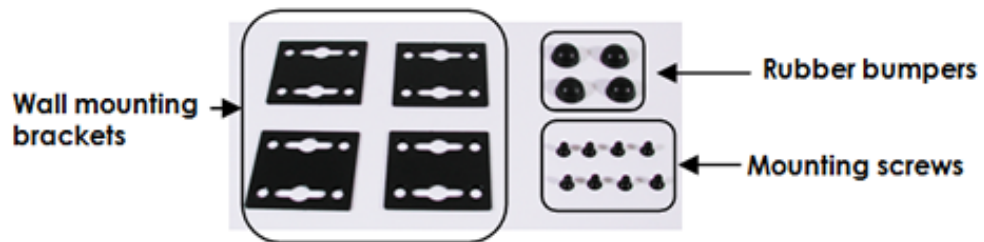

- Mounting Kit and Rubber Bumpers

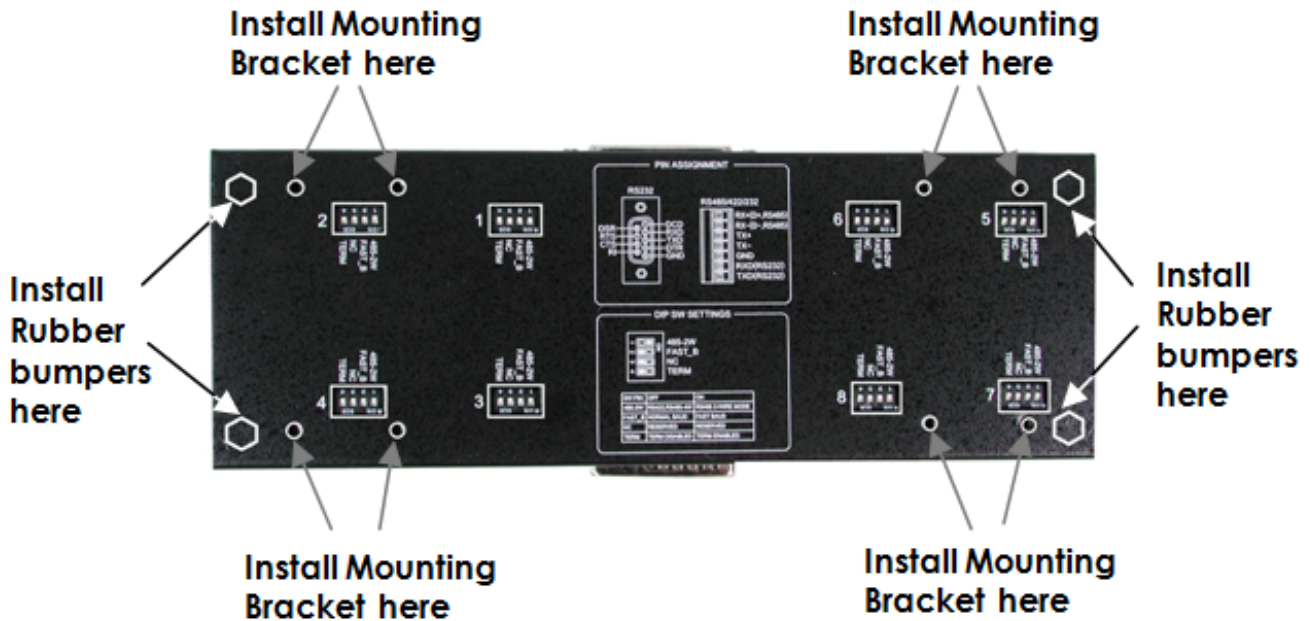

Mode and Terminator Setting Switches

There are 8 4-pin DIP switches marked “1” to “8” on the back side of the Module box for Port 1 to Port 8 respectively. They are used to set RS422 and RS485 modes and configure terminators.

422, 485 Mode and Terminator Switches (1~8 for each port respectively)

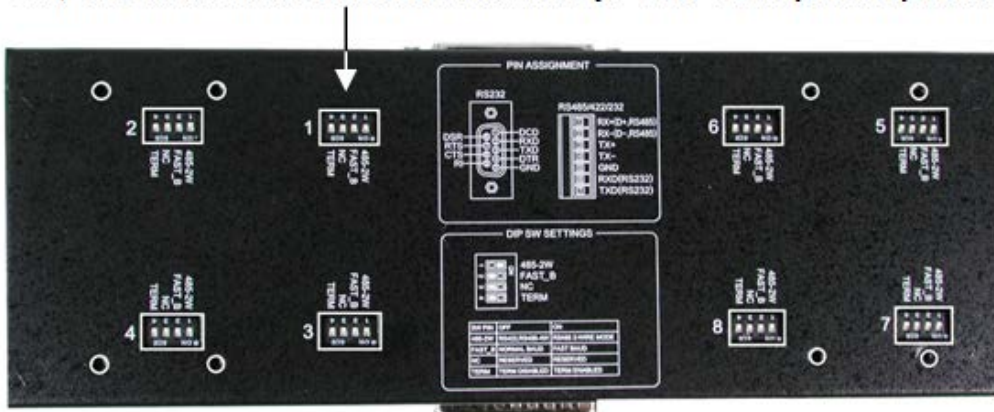

- Pin 1:** To enable RS485 2-wire mode (when ON), set it OFF for either RS485 4-wire or RS422 mode. The switch is nothing about the RS232 mode. The RS232 mode operates with any DIP switch settings.
- Pin 2:** It is reserved to enable fast RS485 2-wire mode (when ON) only, it is used for the future expansion only. Leave it at OFF now.
- Pin 3** It is unconnected
- Pin 4** Enables RS485 (RX+, RX-) Terminator (when ON).



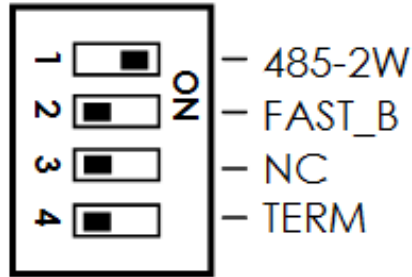

- Mode Setting Table

Switch Settings	Description
<p>1 — 485-2W 2 — FAST_B 3 — NC 4 — TERM</p>	<p>RS485 2-wire mode (Default)</p>
<p>1 — 485-2W 2 — FAST_B 3 — NC 4 — TERM</p>	<p>RS485 4-wire, RS422 mode</p>
<p>1 — 485-2W 2 — FAST_B 3 — NC 4 — TERM</p>	<p>RX+/RX- Terminator is Disabled (Default)</p>
<p>1 — 485-2W 2 — FAST_B 3 — NC 4 — TERM</p>	<p>RX+/RX- Terminator is Enabled</p>



Please note that this product does NOT support hot-plug feature by means of the DB44 Expansion Cable. You can NOT connect or disconnect the expansion cable unless you power off your system first.

1. Turn OFF the system power, remove the chassis cover from your computer
2. Locate an unused PCI slot for the PCI Host Adapter or PCI Express slot for PCIe Host Adapter; remove the corresponding slot cover from computer chassis.
3. Plug the PCI or PCIe add-in Host Adapter in the slot, attached its card bracket to the computer chassis screw. Put the chassis cover back on the computer.
4. Installing the Wall Mounting Brackets or anti-slip rubber bumpers if required:
5. Install the DB44 Cable from the PCI (or PCIe) Host Adapter card to the Module box.

Warning!! Since the Expansion Cable's connector carries proprietary signals but with the same form factor as the standard DB44 connector, please do NOT connect the Expansion Box or the Host Adapter to other products. Improper connection may damage the Expansion Module or the Host Adapter.

6. The Module Box is powered by the DB44 cable from the PCI or PCIe Host Adapter. It requires you to connect a power cable from your system power supply to your Host Adapter, you can choose the 15-pin SATA power connector type or large 4-pin connector type cable, *but don't install both simultaneously*.

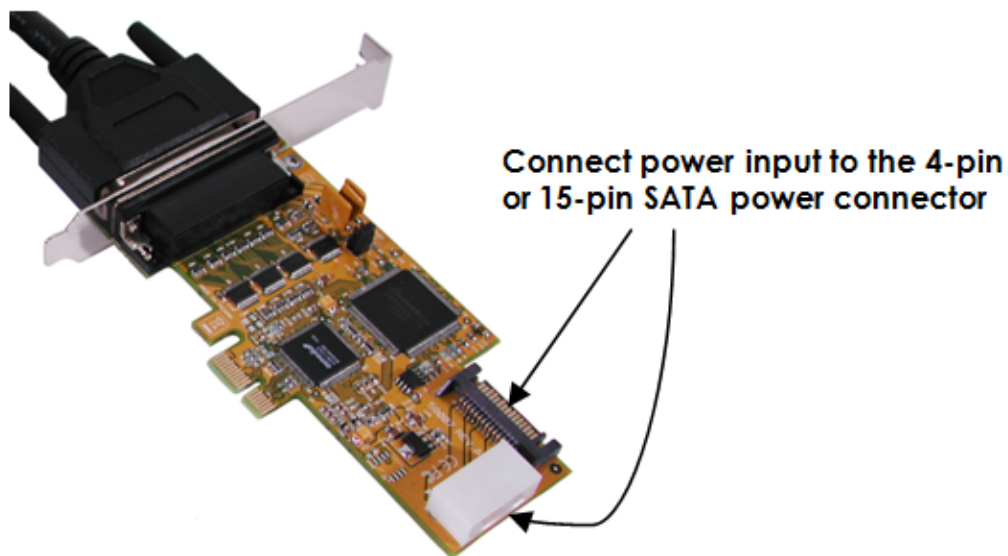

7. If you are connecting a RS232 device to the Module Box, then the DB9 male connectors are required. The RS232 mode does not need any extra DIP switch settings, simply connect to the DB9 connector and leave all 7-pin Terminal Blocks unconnected. The RS232 mode is not set by DIP switches. Instead, it is automatically configured.
8. Turn ON the power of the PC system and proceed with software driver installation.
9. The connection is explained as the following diagram:



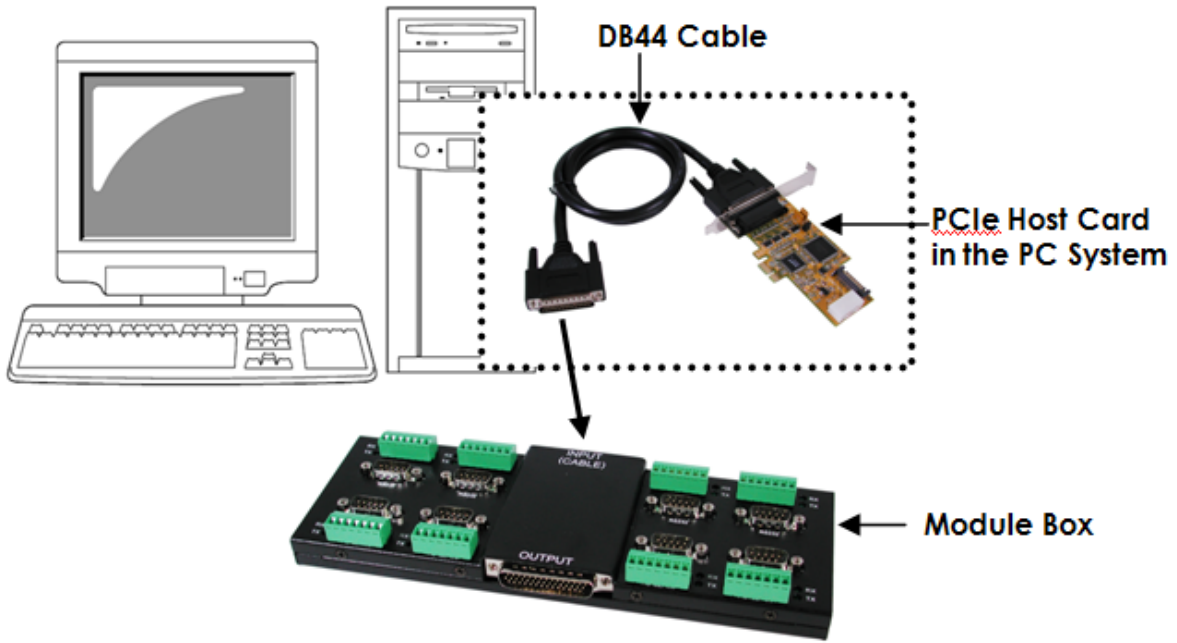

10. Up to 4 Modules can be daisy-chained to provide 32 ports. No other DIP switch or software settings required.

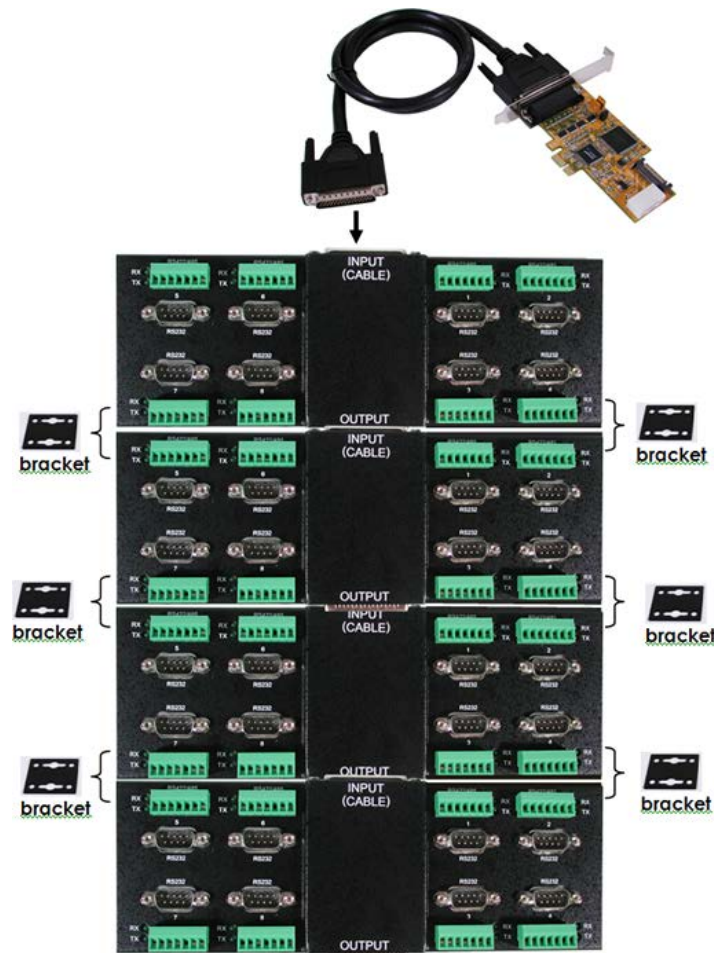

7-pin Terminal Blocks:

RS485/422/232

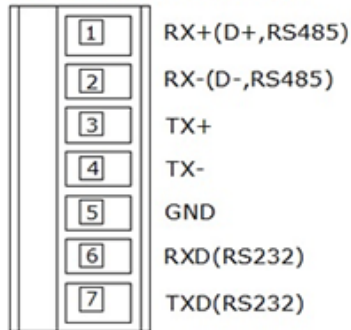

Pin No.	Signal Name	Support Modes
1	RX+ (DATA+)	RS485 2-wire, RS485 4-wire, RS422
2	RX- (DATA-)	RS485 2-wire, RS485 4-wire, RS422
3	TX+	RS485 4-wire, RS422
4	TX-	RS485 4-wire, RS422
5	GND	RS485 2-wire, RS485 4-wire, RS422, RS232
6	RXD	RS232
7	TXD	RS232

DB9 male Connector:

RS232

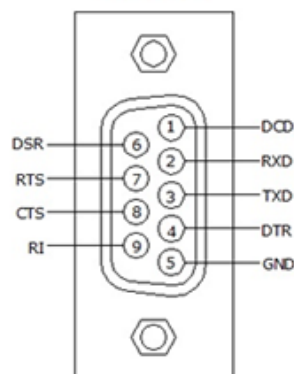

9 Pins	Signal
1	DCD
2	RXD
3	TXD
4	DTR
5	GND
6	DSR
7	RTS
8	CTS
9	RI (Power) *

- ***Note:** The pin 9 of each DB9 male connector supports DC5V or DC12V option depends on the internal jumper settings in the module box and the AC/DC power adapter connected the default factory settings disabled the power and connected it to RI signal.



Type	Specifications
Connectors	Host: DB44 RS422/485: 7-pin 3.5mm Terminal Blocks x 8 RS232- DB9 male connectors x 8
Cable	DB44 Cable
Bus Interface	32-bit PCI (or 1-lane PCI Express)
Number of Ports	8
RS232 Signals	TXD, RXD, GND
RS485 2-wire mode	DATA+, DATA-, GND
RS485 4-wire and RS422 modes	TX+, TX-, RX+, RX-, GND
Baud Rate	110 bps to 921.6Kbps
Data Bits	5,6,7,8
Stop Bits	1, 1.5, 2
I/O address/IRQ	Plug-and-Play (various)
Parity	None, Even, Odd
Flow Control	RTS/CTS, XON/XOFF
Operating Temperature	0 to 55°C(32 to 132°F)
Operating Humidity	5 to 95% RH
Storage Temperature	-20 to 85°C (-4 to 185°F)

