

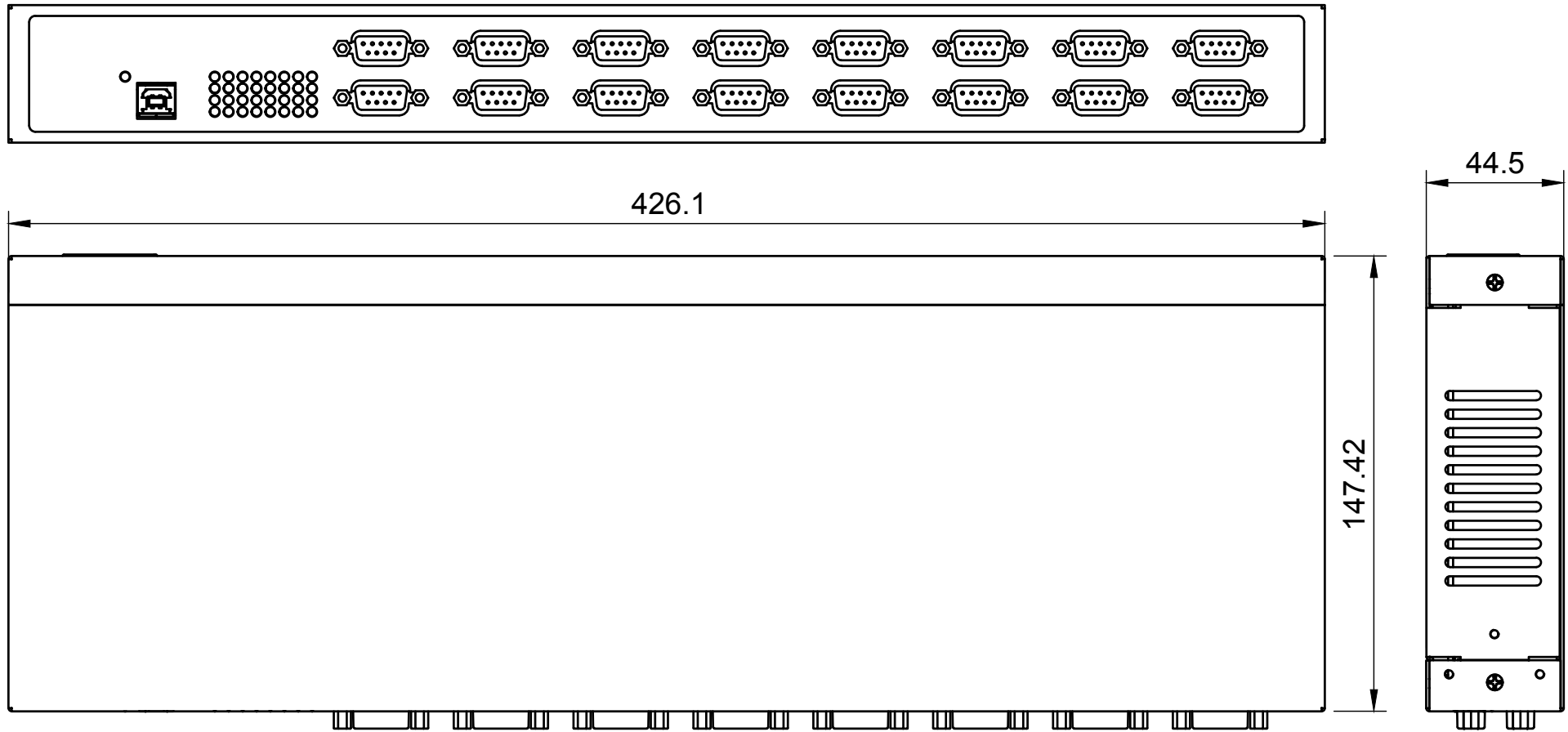



# Basic Measurements

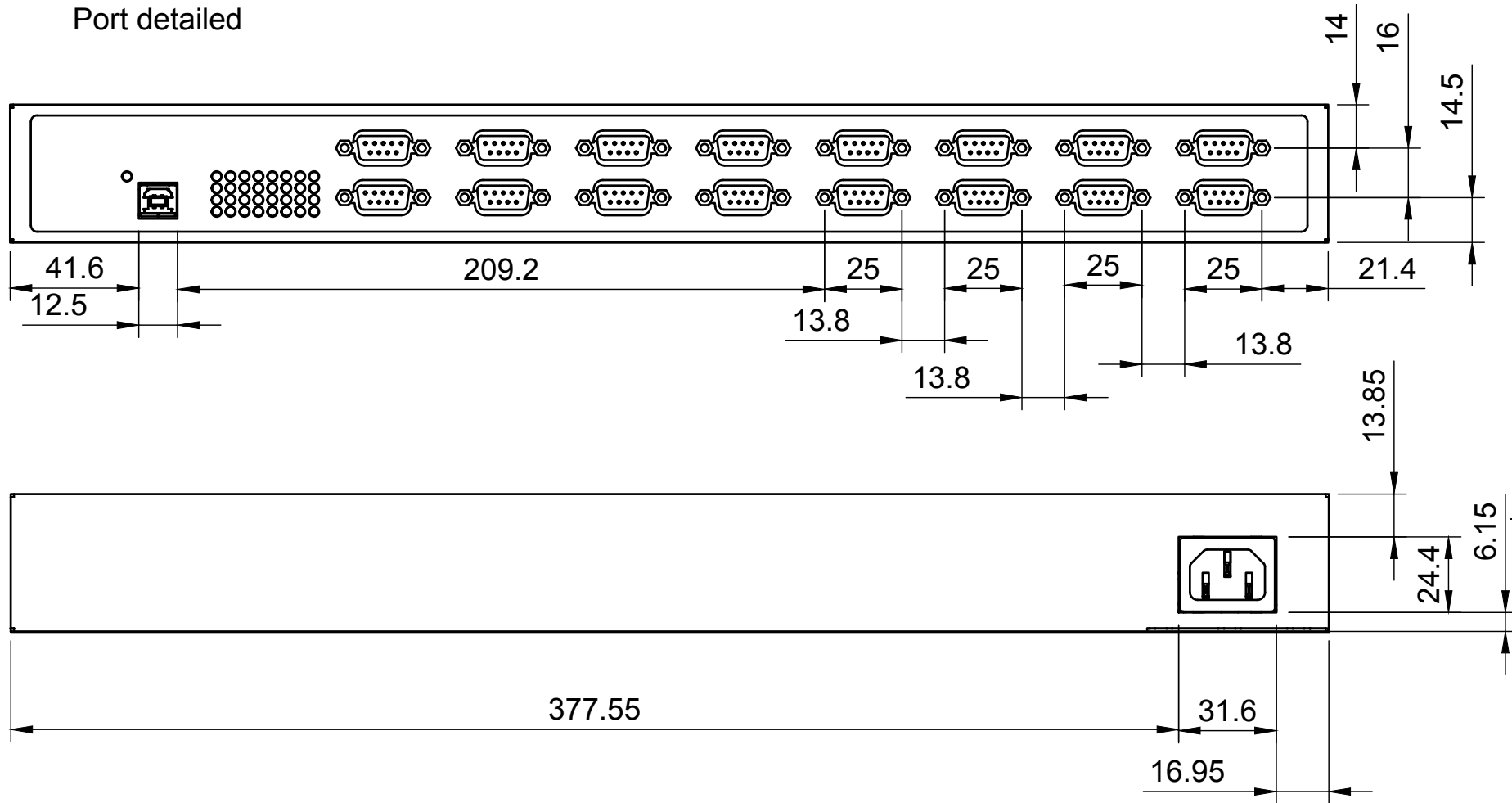

|   |                               |            |
|---|-------------------------------|------------|
|  | Model #: USB-16COM-RM         |            |
|   | Drawn by: Leo Pinto           | Scale: 1:2 |
| Drawn Date: 10/5/21   | Tolerance: +/- 0.15mm         |            |
| Notes:  | Contact: support@coolgear.com |            |
|   | Web: coolgear.com             |            |
|   | A4                            | 1/5        |

Port detailed



|   |                               |            |
|---|-------------------------------|------------|
|  | Model #: USB-16COM-RM         |            |
|   | Drawn by: Leo Pinto           | Scale: 1:2 |
| Drawn Date: 10/5/21   | Tolerance: +/- 0.15mm         |            |
| Notes:  | Contact: support@coolgear.com |            |
|   | Web: coolgear.com             |            |
|   | A4                            | 2/5        |

# Accessories

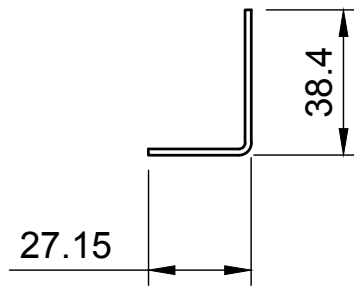
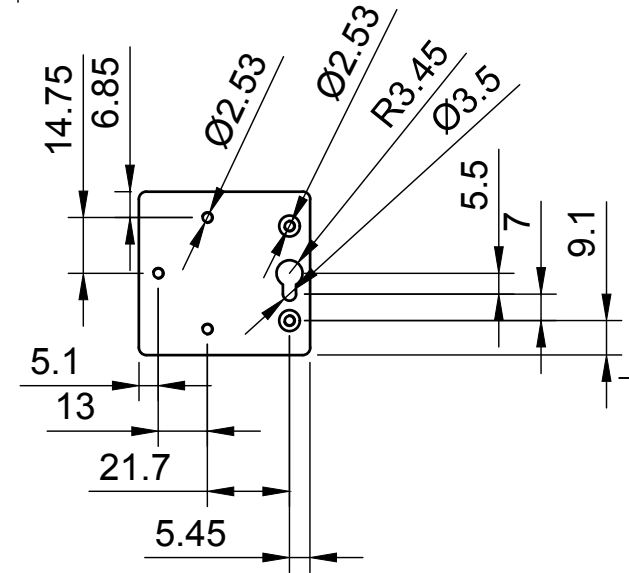
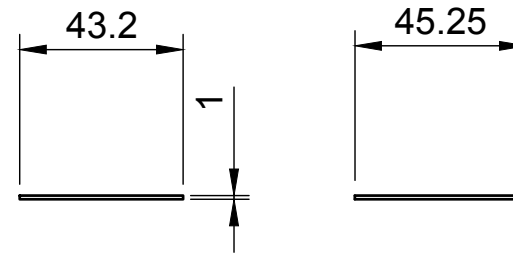
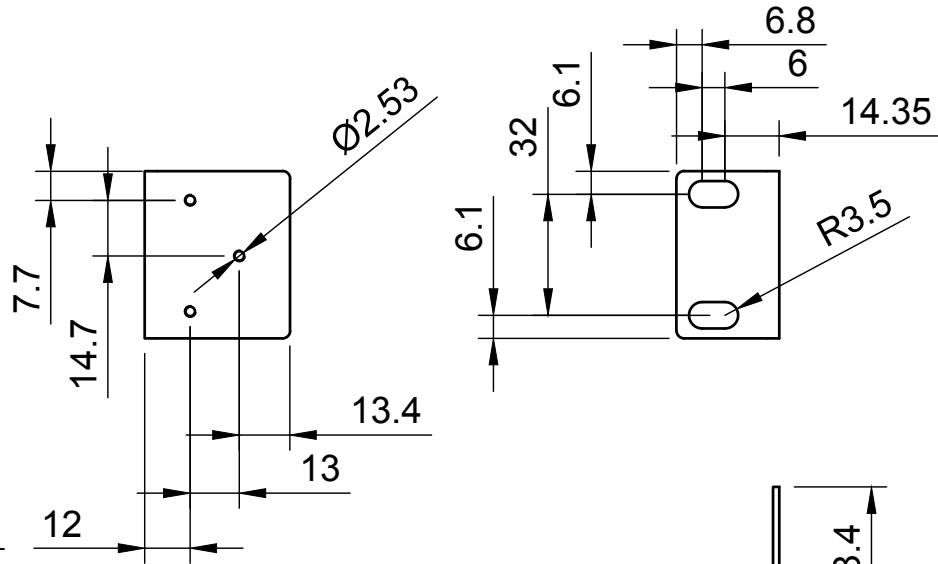

|   |                               |              |  |
|---|-------------------------------|--------------|--|
|  |                               | Model #:     |  |
|   |                               | USB-16COM-RM |  |
| Drawn by: Leo Pinto   | Scale: 1:2                    | Units: mm    |  |
| Drawn Date: 10/5/21   | Tolerance: +/- 0.15mm         |              |  |
| Notes:  | Contact: support@coolgear.com |              |  |
|   | Web: coolgear.com             |              |  |
|   | A4                            | 3/5          |  |

Exploded View  
Rackmount Brackets

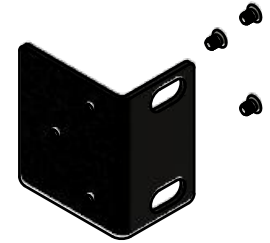

|   |  |                               |           |
|---|--|-------------------------------|-----------|
|  |  | Model #:<br>USB-16COM-RM      |           |
| Drawn by: Leo Pinto   |  | Scale: 1:2                    | Units: mm |
| Drawn Date: 10/5/21   |  | Tolerance: +/- 0.15mm         |           |
| Notes:  |  | Contact: support@coolgear.com |           |
|   |  | Web: coolgear.com             |           |
|   |  | A4                            | 4/5       |

Exploded View  
Surfacemount Brackets



|   |  |                               |           |
|---|--|-------------------------------|-----------|
|  |  | Model #:<br>USB-16COM-RM      |           |
| Drawn by: Leo Pinto   |  | Scale: 1:2                    | Units: mm |
| Drawn Date: 10/5/21   |  | Tolerance: +/- 0.15mm         |           |
| Notes:  |  | Contact: support@coolgear.com |           |
|   |  | Web: coolgear.com             |           |
|   |  | A4                            | 5/5       |