

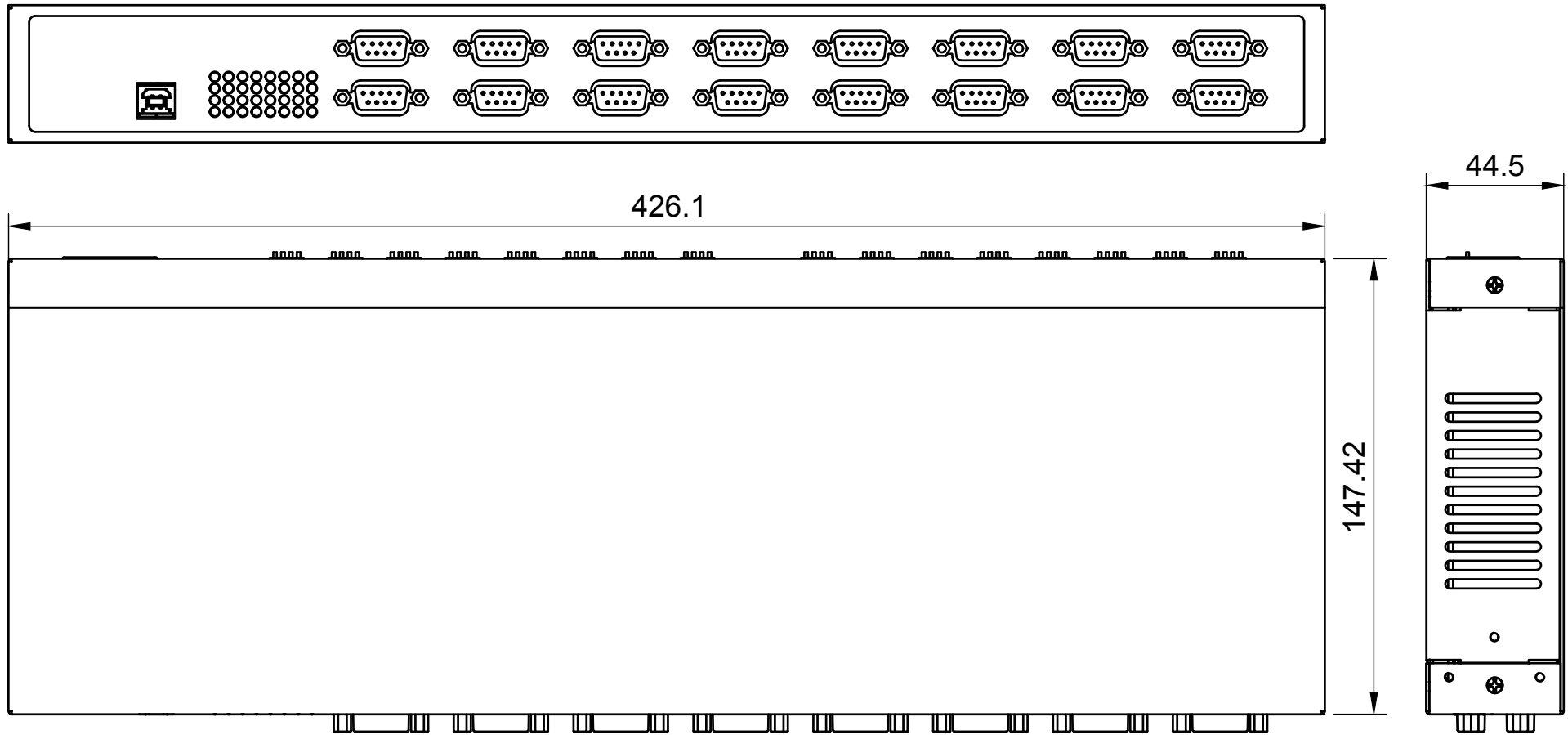



Basic Measurements

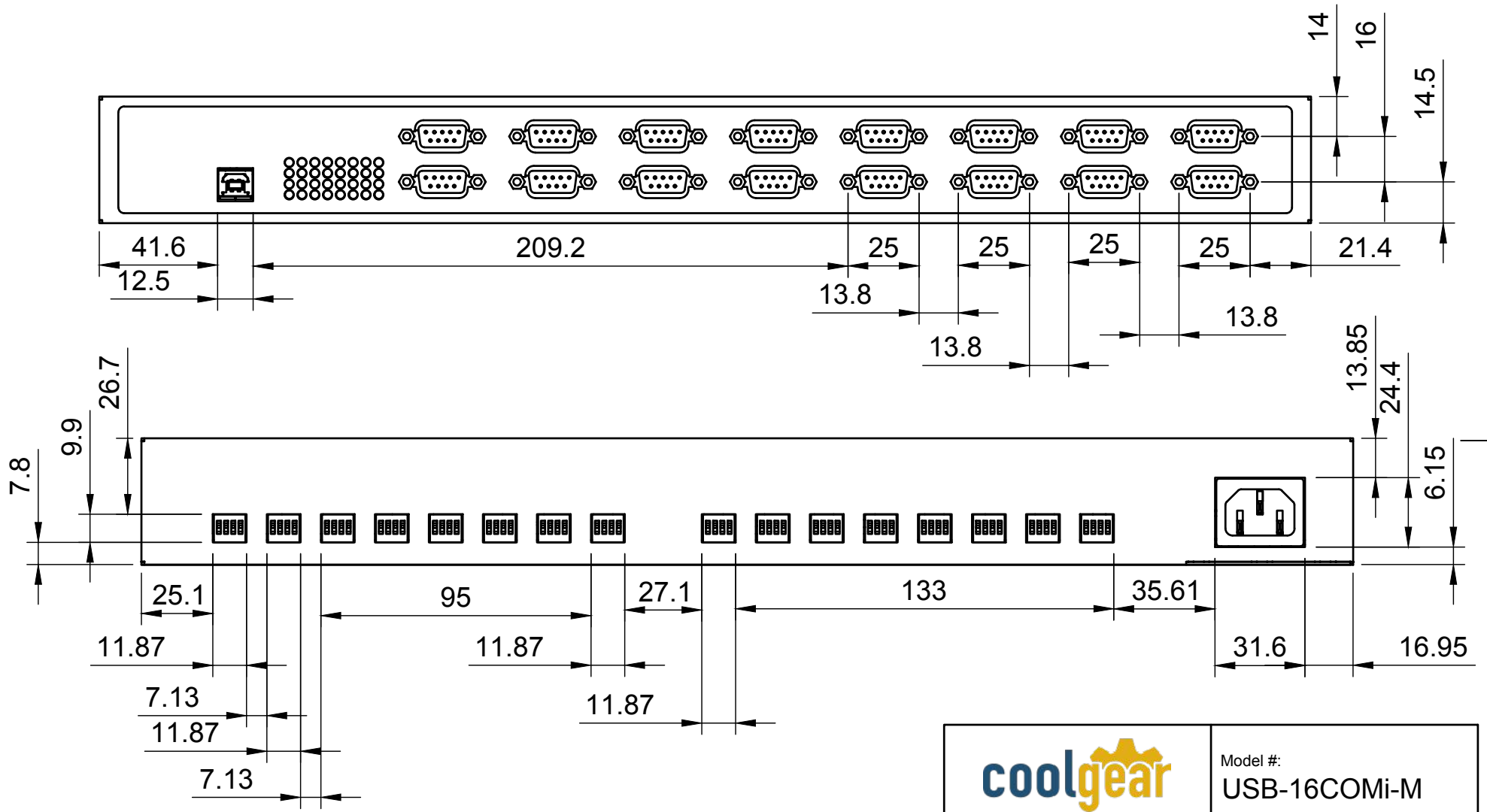

	Model #: USB-16COMi-M	
	Drawn by: Leo Pinto	Scale: 1:2
Drawn Date: 10/21/21	Tolerance: +/- 0.15mm	
Notes:	Contact: support@coolgear.com	
	Web: coolgear.com	
	A4	1/4

Port detailed



		Model #:	
		USB-16COMi-M	
Drawn by: Leo Pinto		Scale: 1:2	Units: mm
Drawn Date: 21/10/21		Tolerance: +/- 0.15mm	
Notes:		Contact: support@coolgear.com	
		Web: coolgear.com	
		A4	2/4

Accessories

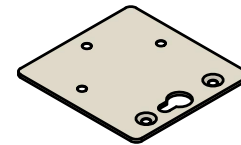
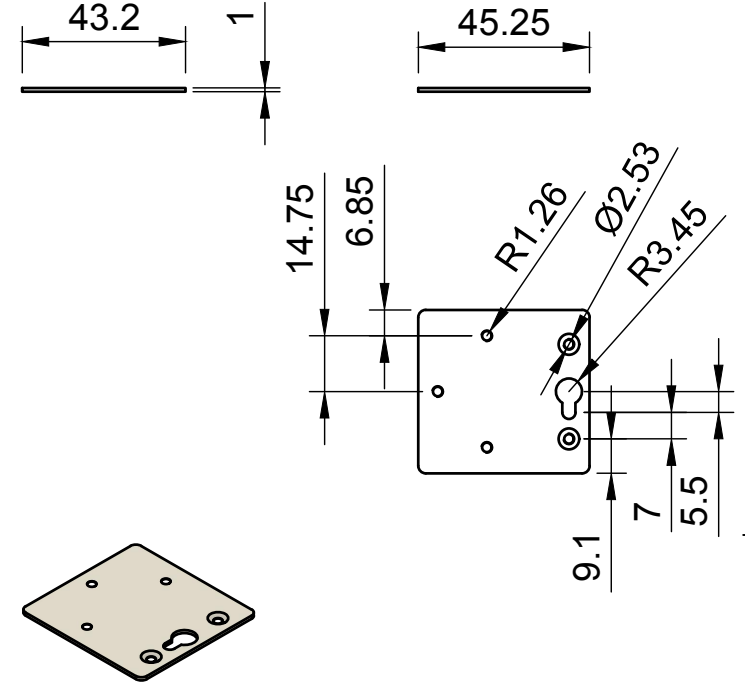
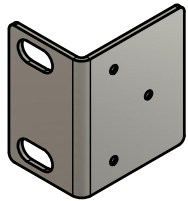
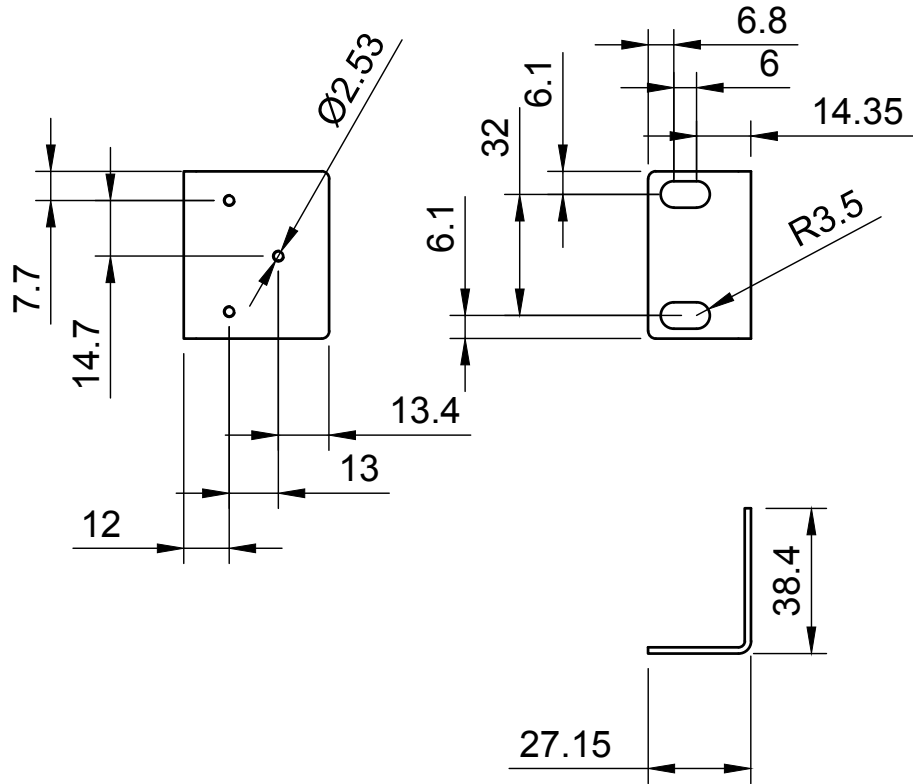

		Model #:	
		USB-16COMi-M	
Drawn by: Leo Pinto	Scale: 1:2	Units: mm	
Drawn Date: 21/10/21	Tolerance: +/- 0.15mm		
Notes:	Contact: support@coolgear.com		
	Web: coolgear.com		
	A4	3/4	

Exploded View

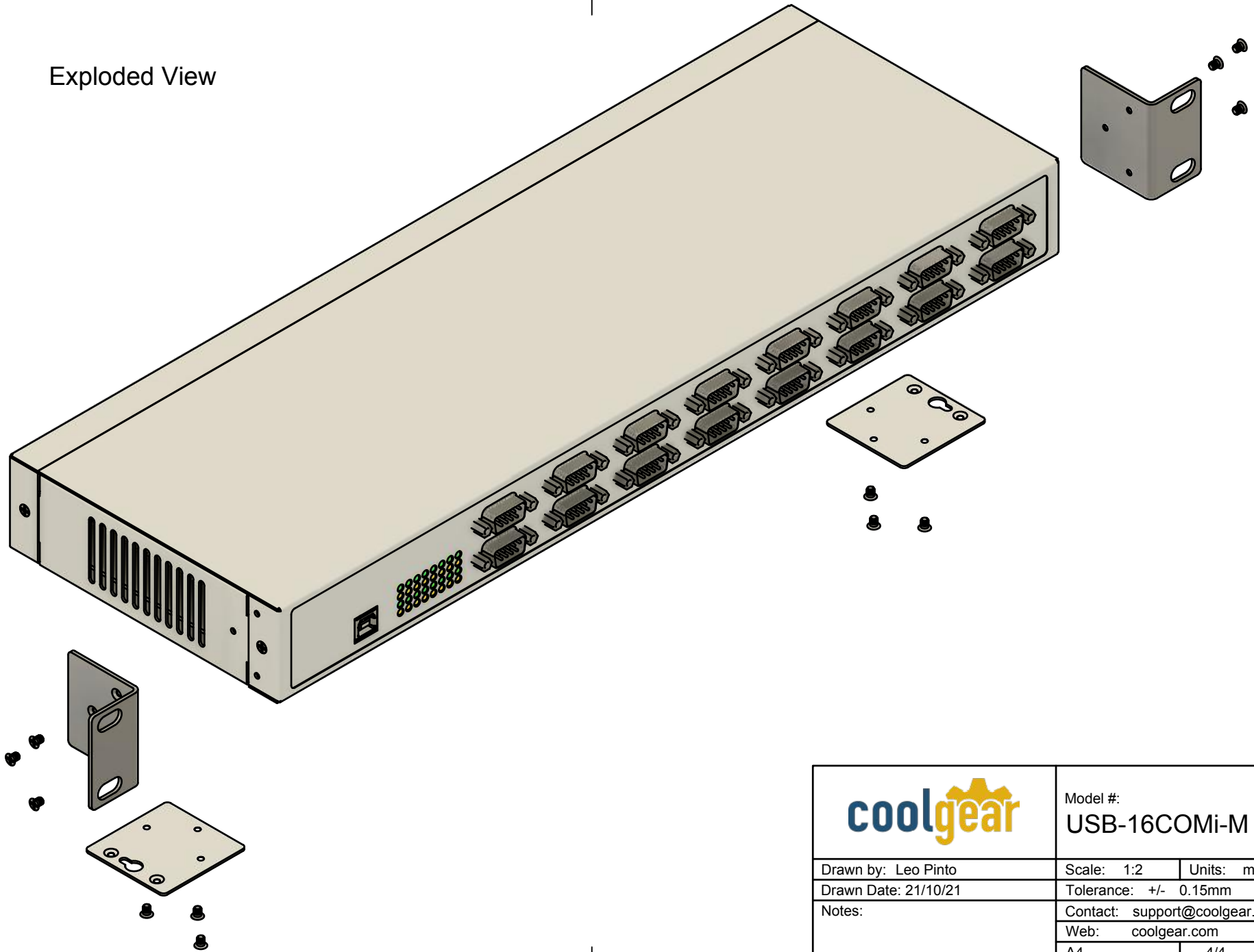

Model #:
USB-16COMi-M

Drawn by: Leo Pinto

Scale: 1:2 | Units: mm

Drawn Date: 21/10/21

Tolerance: +/- 0.15mm

Notes:

Contact: support@coolgear.com

Web: coolgear.com

A4

4/4