

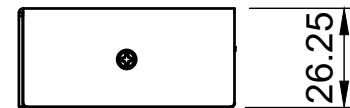

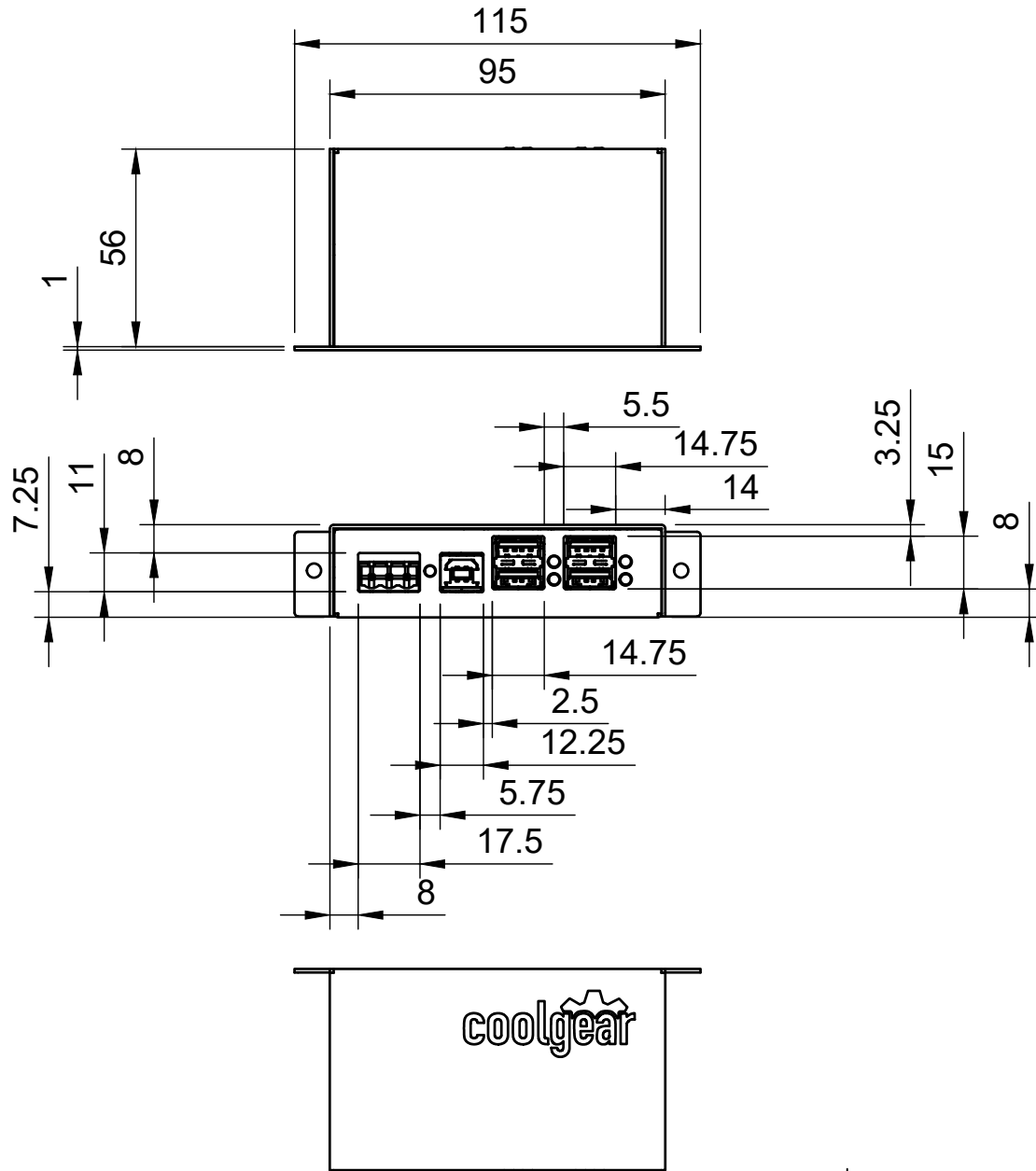

Basic Measurements
Port Detailed Measurements

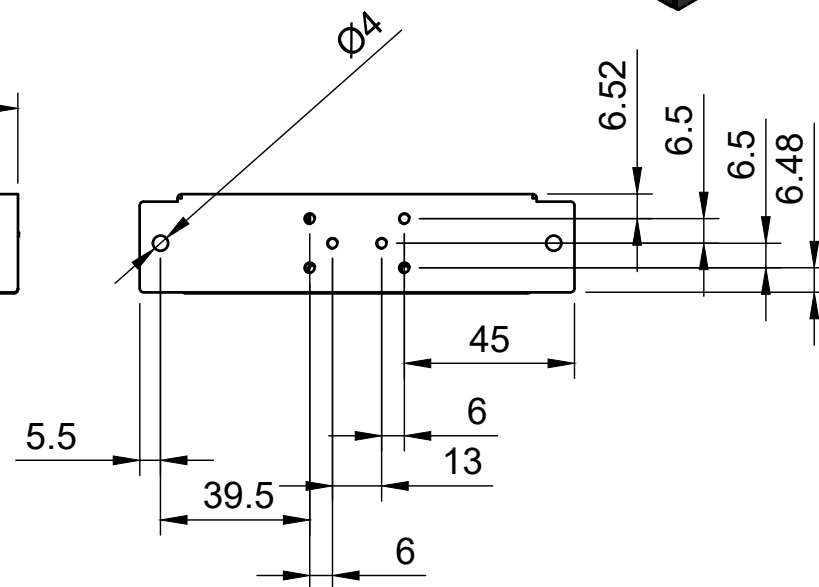
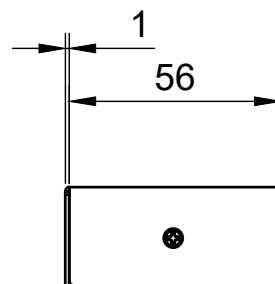
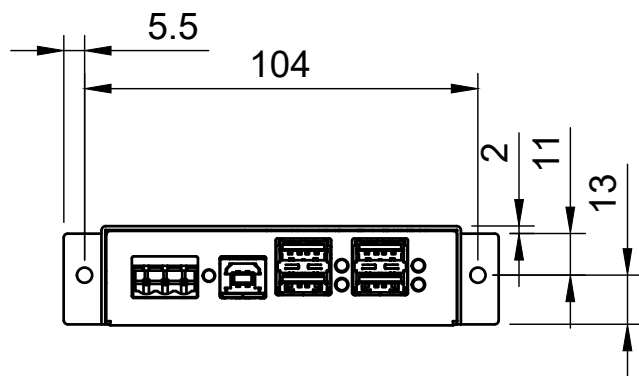

		Model #:	
		USBG-4U2ML	
Drawn by: Leo Pinto		Scale: 1:2	Units: mm
Drawn Date: 4/23/2021		Tolerance: +/- 0.15mm	
Notes:		Contact: support@coolgear.com	
		Web: coolgear.com	
		A4	1/3

Mounting Holes



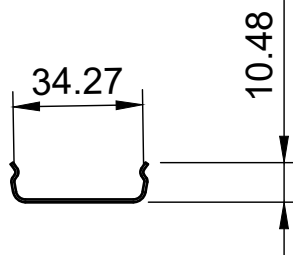
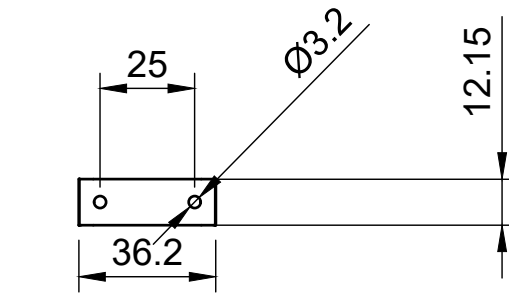
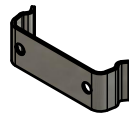
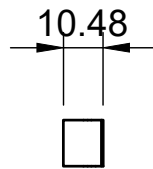
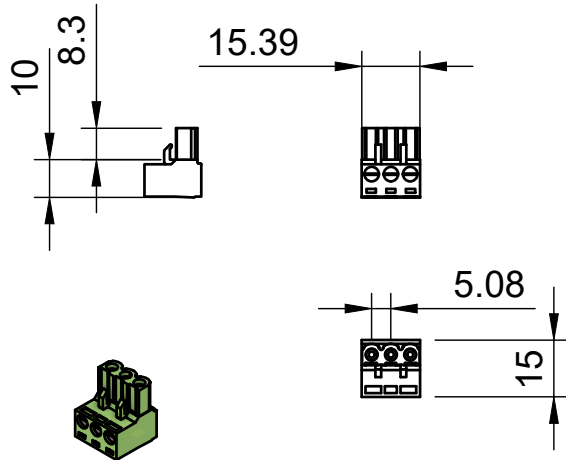

		Model #: USBG-4U2ML	
Drawn by: Leo Pinto		Scale: 1:2	Units: mm
Drawn Date: 4/23/2021		Tolerance: +/- 0.15mm	
Notes:		Contact: support@coolgear.com	
		Web: coolgear.com	
		A4	2/3

Accessories

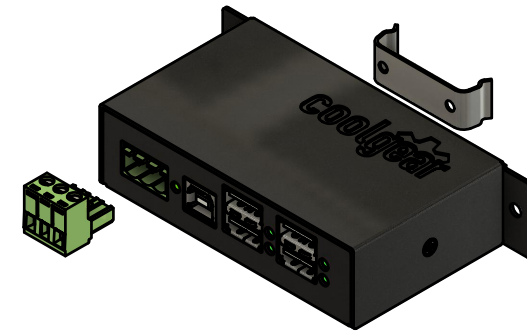

Exploded View



		Model #:	
		USBG-4U2ML	
Drawn by: Leo Pinto		Scale: 1:2	Units: mm
Drawn Date: 4/23/2021		Tolerance: +/- 0.15mm	
Notes:		Contact: support@coolgear.com	
		Web: coolgear.com	
		A4	3/3