

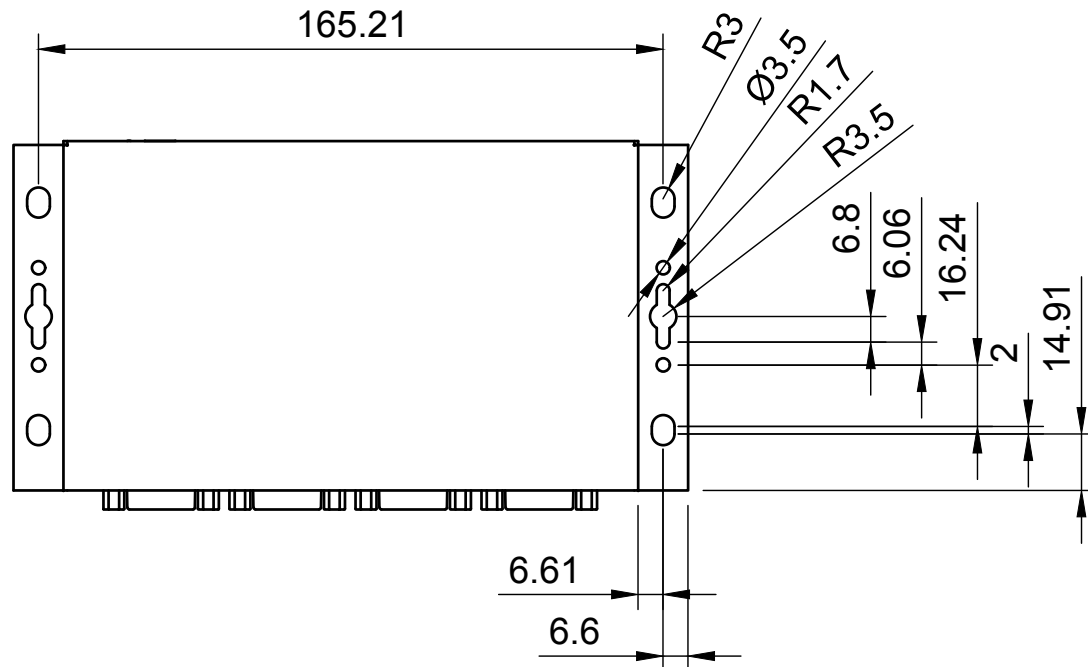

Basic Measurements
Mounting Holes

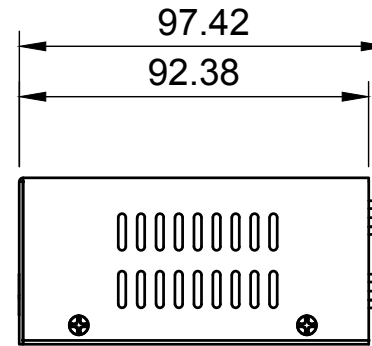
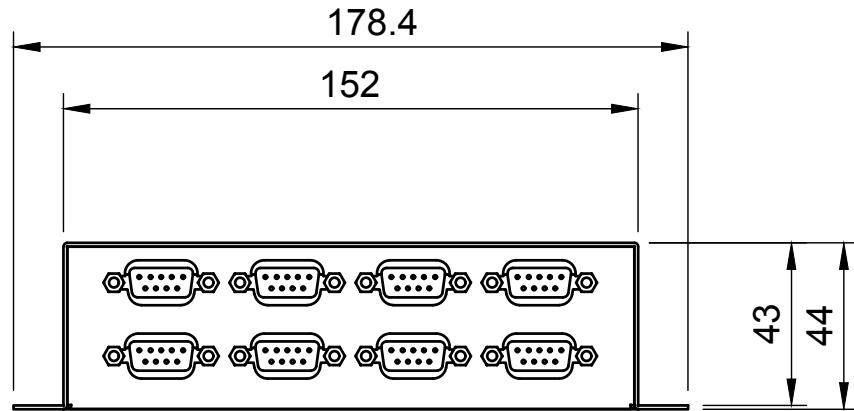

		Model #:	
		CM-41082	
Drawn by: Leo Pinto		Scale: 1:2	Units: mm
Drawn Date: 6/23/21		Tolerance: +/- 0.15mm	
Notes:		Contact: support@coolgear.com	
		Web: coolgear.com	
		A4	1/2

Ports detailed

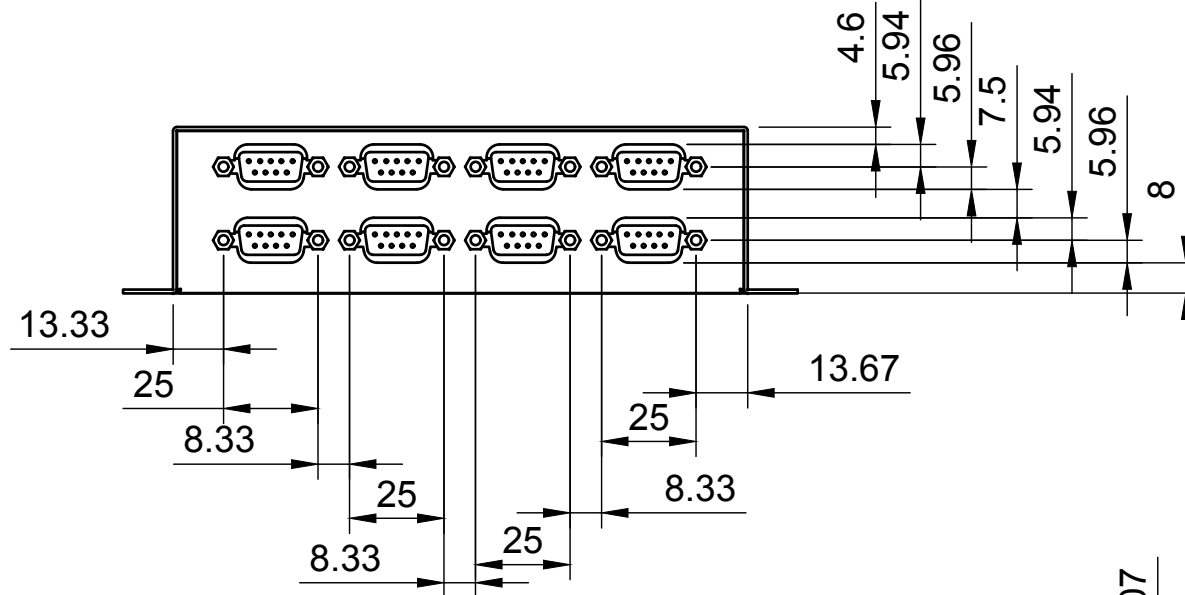

A (1:1)

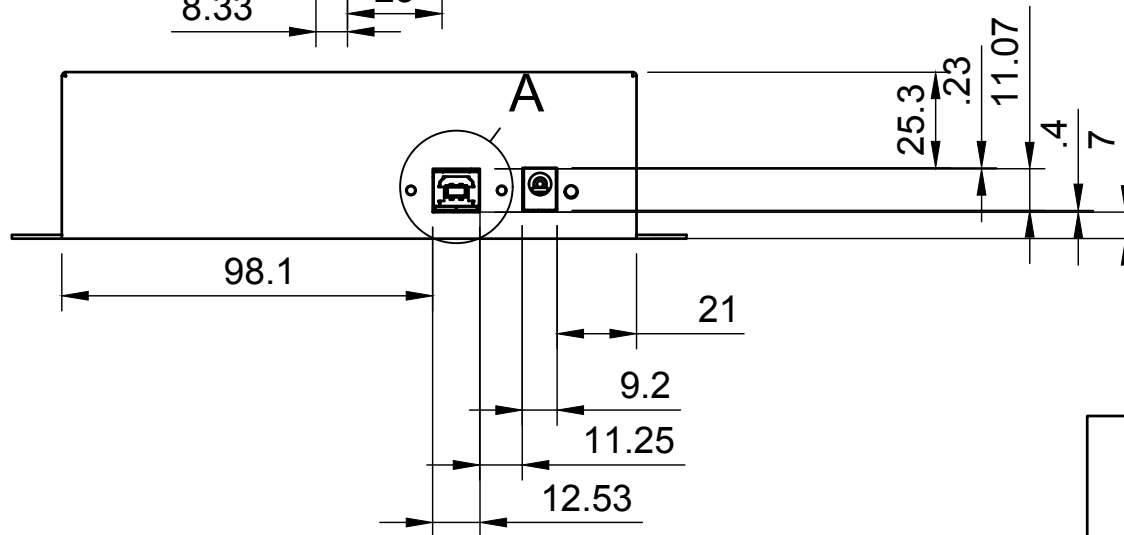

2x 4-40 UNC 2B x 5/5

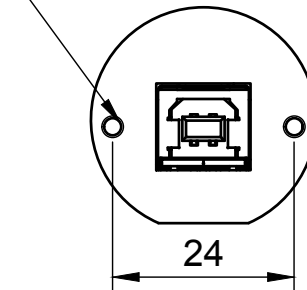

		Model #:	
		CM-41082	
Drawn by: Leo Pinto		Scale: 1:2	Units: mm
Drawn Date: 6/23/21		Tolerance: +/- 0.15mm	
Notes:		Contact: support@coolgear.com	
		Web: coolgear.com	
		A4	2/2