



USB 2.0 10-Port Industrial High Power 2.1A Charger Hub

Product Manual



Coolgear, Inc.

Version 1.1

September 2017

Model Number: USBG-10XU1

Revision History

Revision	Date	Author	Comments
1.0	07/14/2015	Coolgear	Original format
1.1	09/25/2017	Coolgear	New Manual Format

About this document

This product manual outlines installation and features of the USBG-10XU1 USB 2.0 10-Port Industrial High Power 2.1A Charger Hub.

Scope

The scope of this manual is to give the user of the product an understanding of its use with detailed diagrams and verbiage. The manual allows the users to apply the product to their application.

Intended Audience

This product is intended for use in numerous industries including but not limited to applications such as; Automotive Environments, Airports, Warehouse, and others.

Product Support

support@coolgear.com

Table of Contents

1. Introduction	4
1.1 Features	4
1.2 Specifications	5
2. Package Contents	6
2.1 Physical Diagram	6
2.2 Rack Mounting	7
2.3 Connection	8
2.4 Charging Mode	10
2.5 Sync Mode	11
2.6 Daisy Chain (Cascade) Connection	12
2.7 Regulatory Compliance	14
2.8 Environmental Specifications	15
3. Notes, Tips, Warnings, and Safety	16
4. Supporting References	17

Table of Figures

Figure 1 – Front View	6
Figure 2 – Rear View	6
Figure 3 - Rack Mounting	7
Figure 4 – Cabinet Mounting	8
Figure 5, 6, 7, 8, 9, 10 – Connection	8-10
Figure 11 – Charging Mode	10
Figure 12 – Sync Mode	11
Figure 13, 14, 15, 16, 17 – Daisy Chain (Cascading)	12-17

1. Introduction

CM-10XU1 is a 10-port USB Hub with Charger, a smart solution for charging or sync of several iPads, iPhones, iPods and USB charging devices operating simultaneously. This is a perfect tool to eliminate the jumble of wires and chargers and also is ideal for large capacity USB station in-house for automated duplication tasks. Places such as school's class room, businesses conference or meeting in organizations.

WEIGHT	2.206 lbs
DIMENSIONS	10.562(L) x 4.083(W) x 1.760in(H)
UPC	736983900302
WARRANTY	1 year from date of purchase
COLOR	Black
DOWNSTREAM PORTS	10 USB Type-A Female Ports
UPSTREAM PORTS	1 USB Type-B Port
SYSTEM REQUIREMENTS	Compatible with all USB enabled operating systems.

1.1 Features

- Charges or syncs up to 10 / 20 iPads, iPods, iPhones or other USB-charged in charge mode devices, providing each USB port with the optimum charge level for each device.
- Will also charge virtually any other device that can be charged through a powered USB port.
- Supports High Speed 480Mbps, full speed 12Mbps and low speed 1.5Mbps operation.
- Fully compatible with all USB compliant device.
- Ten (10) Hi-Speed USB 2.0 downstream ports.
- Over-current detection and protection.
- Surge & ESD Protection.
- Extends up to optimum 40 USB devices by connecting cascade port with another USB 2.0 charge hub(s); to see notes under specification.
- Supports Windows OS: 98SE / ME / 2000 / XP / Vista / 7 / 8 / 8.1, Mac OS 8.6 / 9.x / 10.x or higher.
- Rack mountable.

1.2 Specifications

Model No.	USBG-10XU1
Chip	Terminus
USB Specification	USB 1.1 / 2.0 Compliant
Connector Upstream	USB Type-B Female
Connector Downstream	USB Type-A x10
Connector Cascade	USB Type-A
LED Charge Mode	Red Color x10
Power Mode	External Power Adapter
Power Consumption	24VDC 6.25A
LED SYNC Mode	Orange Color x10
Cable Length	1.8m
Speed	480 /12/1.5 Mbps
Current per Port	5VDC 2100mA
Dimensions (L x W x H)	268 x 102 x 40 mm
Housing	Metal

2. Package Contents

- 1) USB 2.0 Charge Hub
- 2) 24VDC 6.25A Power adaptor with power cord
- 3) USB 2.0 A/M to B/M cable
- 4) Mounting brackets with screws
- 5) User manual

2.1 Physical Diagram

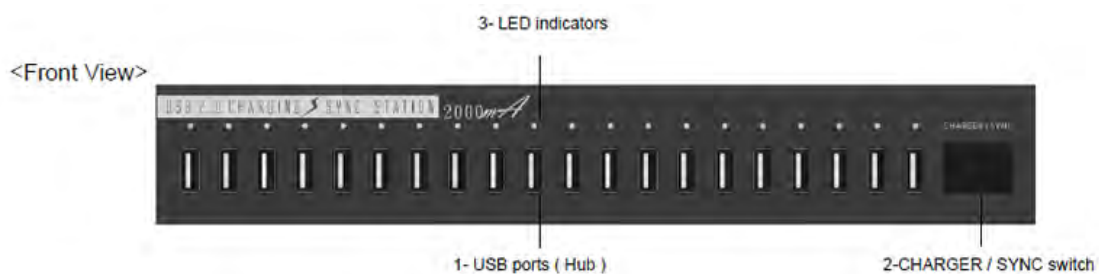

Figure 1



Figure 2

1) USB Ports (Hub) – Allows Connecting iPad, tablet, or USB devices

- Beware that this unit does not require a host computer connected to the hub for it to charge compatible devices.
- This unit does not contain accessory set of cables for iPad, tablet. Please check with your distributor regarding of using appropriate cable.

2) CHARGER / SYNC Switch

- Allows to switch charging or sync mode under connecting with iPad, tablet.
- Charging mode (indicators light on): to charge the objective USB devices.
- Sync mode (indicators light off): to synchronize data from computer to objective USB devices, but not allowed charging.

3) LED Indicators

- LED lights up: indicates which tablet or USB device is connected successfully.
- The LED may not light up when the unit is connecting with some specific USB devices, but it is still working on charging or synchronizing.

4) Power Switch

- User may switch power to on / off.

5) Power Jack

- To use with power adapter provided.

6) USB for Extending 2nd Unit

- It is available to connect with another unit for the purpose of extending.

7) USB Port for Computer

- It is available to connect with host computer by USB cable.

2.2 Rack Mounting

1) Use the mounting brackets and screws onto rack.

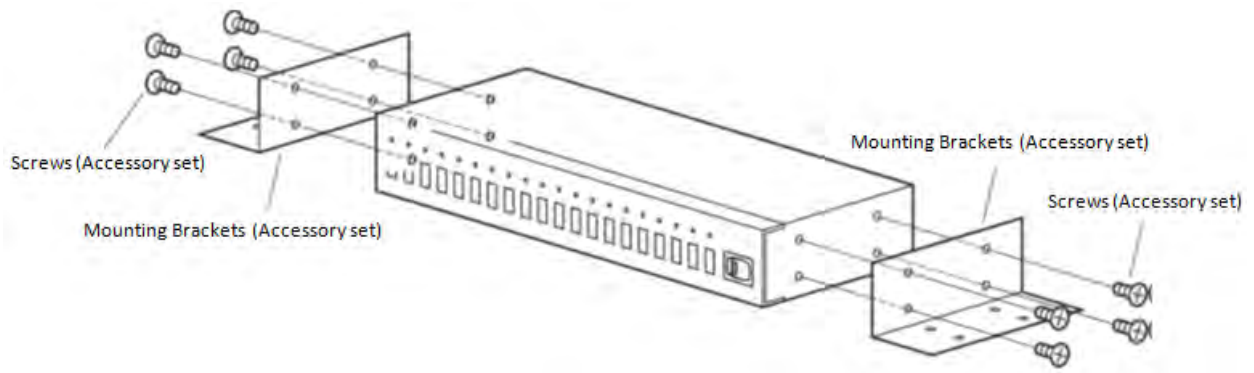

Figure 3

2) User may install on the applicable cabinet, rack environments.

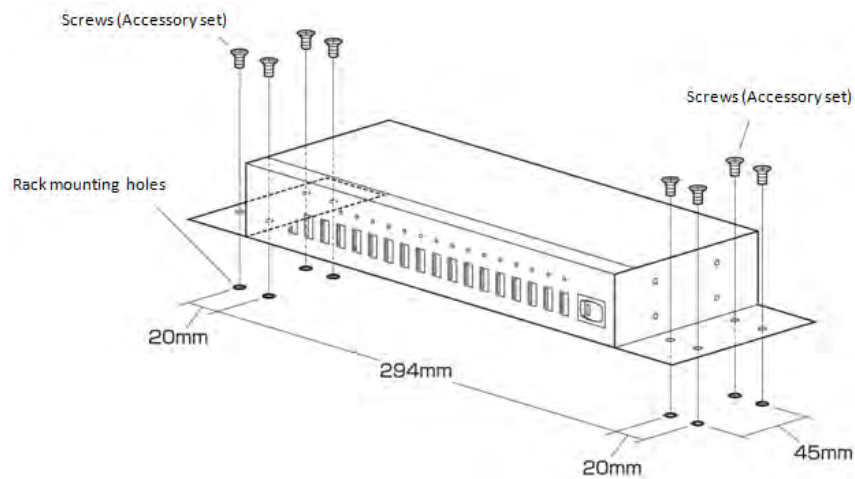

Figure 4

2.3 Connection

- 1) To turn off power switch. **(Rear Panel)**

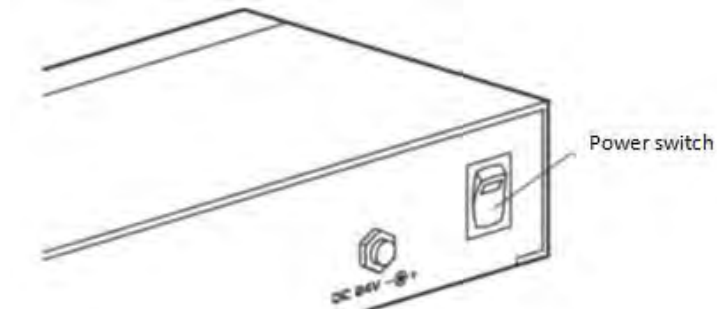

Figure 5

- 2) Plug the power adapter to the unit's power jack.
 - The power jack is threaded with nut, so user may put power DC plug into the power jack without losing connection.

- 3) Put the plug of power adapter into the wall socket. **(Rear Panel)**

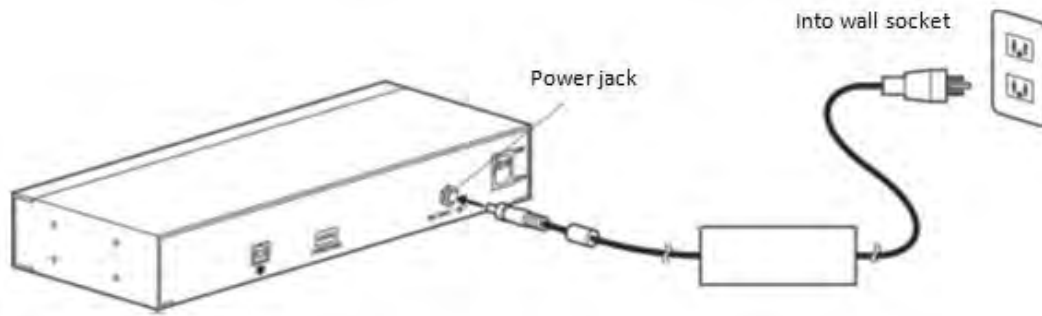

Figure 6

- 4) Turn on the power switch. **(Rear Panel)**

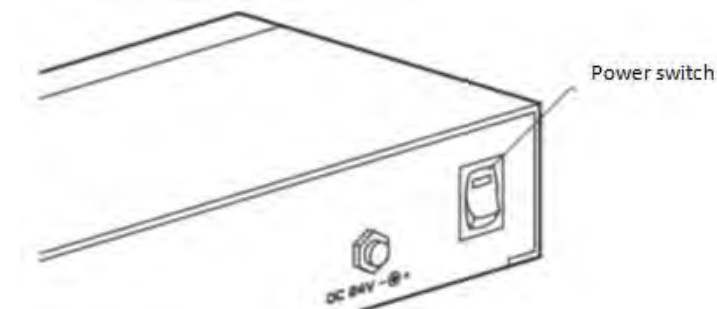

Figure 7

- 5) Using the USB A to B cable provided and connects the USB B end on the unit.
- 6) Using the USB A end and connects on your host computer.

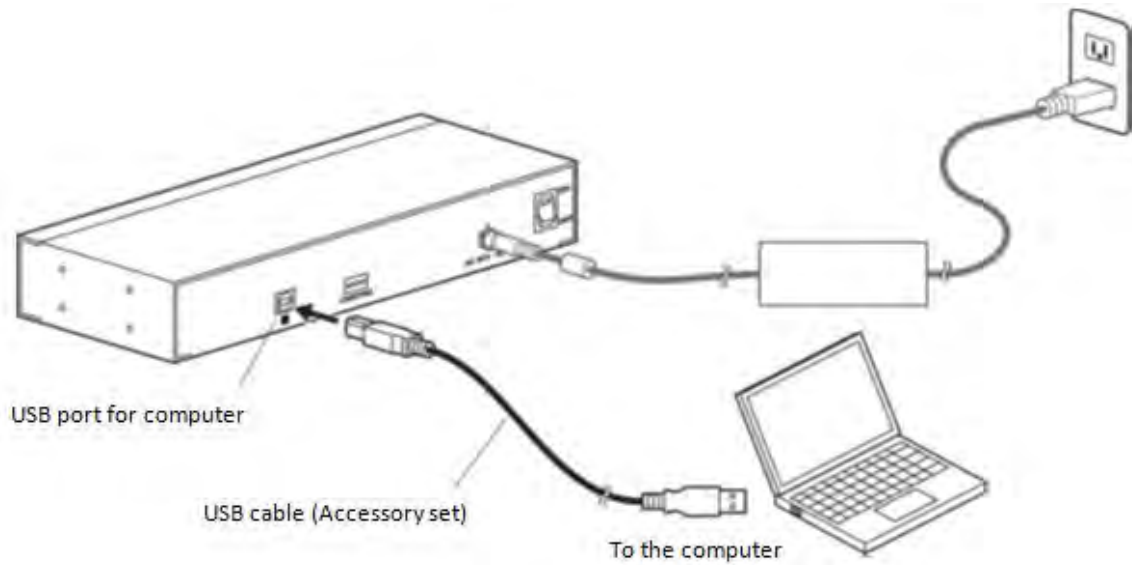

Figure 8

- 7) In according to the previous instruction of connection with host computer, and connects host computer with the unit. (Rear Panel)

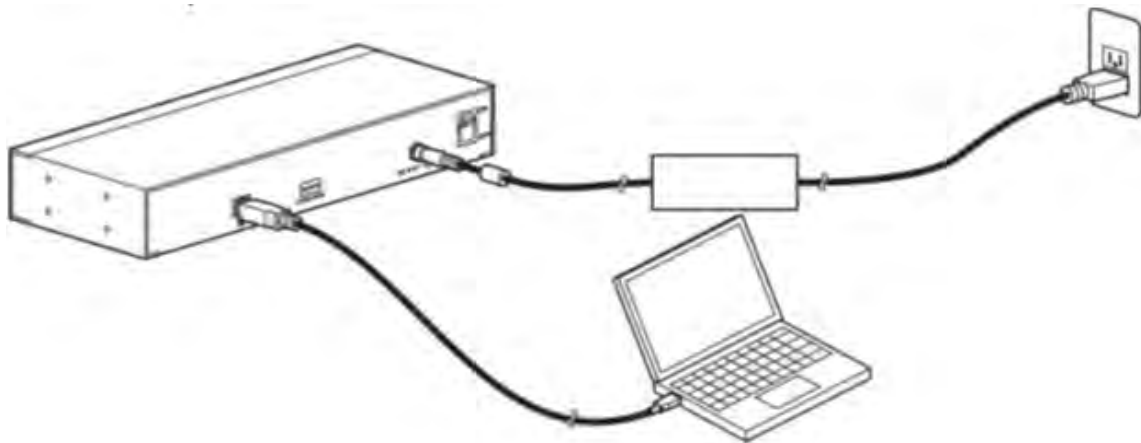

Figure 9

- 8) To use USB cable and connects with tablet or USB devices to the USB ports (Front Panel).

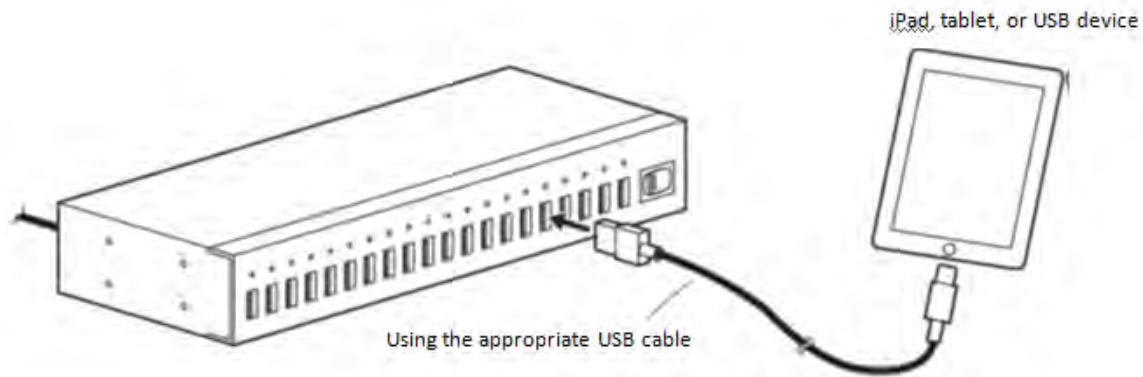

Figure 10

2.4 Charging Mode

Please follow below ways for charging USB devices.

- 1) In according to the previous instruction of connection with host computer, and connects host computer with the unit.
- 2) Turn the switch of CHARGER / SYNC to [CHARGER], and LED lights up.

(Front Panel)

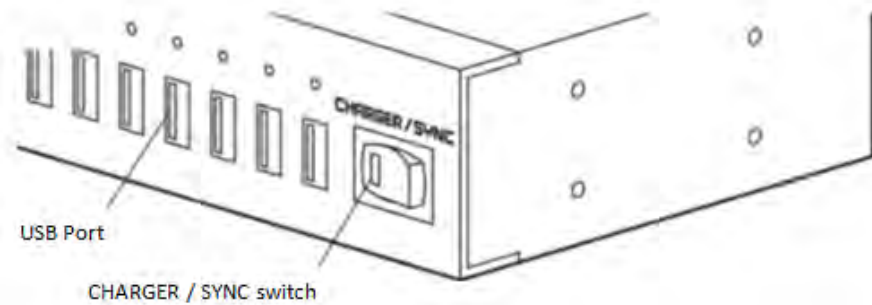

Figure 11

- 3) Connect your USB devices to the USB ports on the hub.
 - This unit does not contain accessory set of cables for iPad, tablet. Please check with your distributor regarding of using appropriate cable.
 - The LED may not light up even the unit can charge the iPad, tablet that is discharged completely. User may charge for a while and disconnect. Try to re-connect and charge again.

2.5 Sync Mode

Please follow below ways for synchronizing.

- 1) In according to the previous instruction of connection with host computer, and connects host computer with the unit.
- 2) Turn the switch of CHARGER / SYNC to [SYNC], and LED lights off.

(Front Panel)

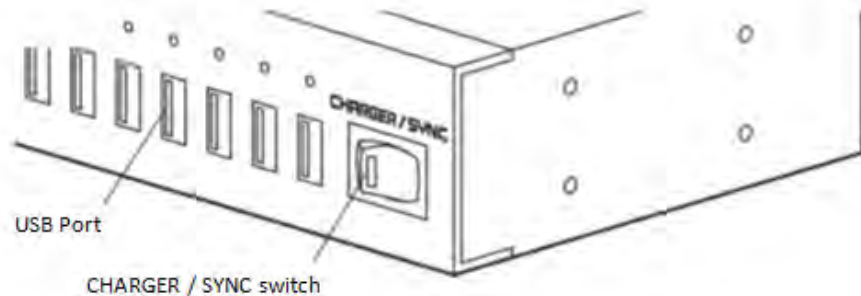

Figure 12

[For host computer configuring iTunes]

- Please create a library folder on host computer for synchronizing and transfers data to iPad.
- Recommends automatic updates in your iTunes preferences (to avoid interference with automatic syncing). Please check for updates manually to keep your software up to date.

[For iPad, tablet configuring]

- Ensure each iPad, tablet has been charged completely at first if the objective iPad, tablet is new goods.
- Please use the unit to synchronize iPad, tablet one after another, and configure at same way. (Login name, ID, the data you want to synchronize etc.)
- The user may adjust the brightness of screen when you are using the unit to synchronize iPad.
- When the user may be requested by iTunes to configure manually, you will have to copy the configuration manually for each iPad.

[For host computer connection & sync]

- Connect iPad, tablet to the USB ports of front panel if each iPad, tablet is configured completely.

- This unit does not contain accessory set of cables for iPad, tablet. It is especially important to use appropriate cables (USB-A to device-specific connector) provided by the device manufacturer.
- Get started synchronizing automatically once you connect the unit.
- It may take a little while for this unit to recognize and sync. Please do not stop by the way once the unit starts synchronizing.
- This unit may not perform sync with charging simultaneously.

[For iOS update]

- User may not perform the iPad update when iPad is connected. You must update iOS on iPad one after another.

2.6 Daisy Chain (Cascade) Connection

This unit can extend another unit for daisy chain (Cascade) connection, the 2nd unit can sync simultaneously as well.

- Maximum 2 units can be connected. (It allows connecting or charging maximum up to 20/40 USB devices simultaneously.)
- If user connects with two units, the 2nd unit may not be detected by some computers which have built in USB 3.0 hub.

In according to the previous instruction of connection with host computer, and connects host computer with the 1st unit. **(Rear Panel)**

- 1) In according to the previous instruction of connection with host computer, and connects host computer with the 1st unit. **(Rear Panel)**

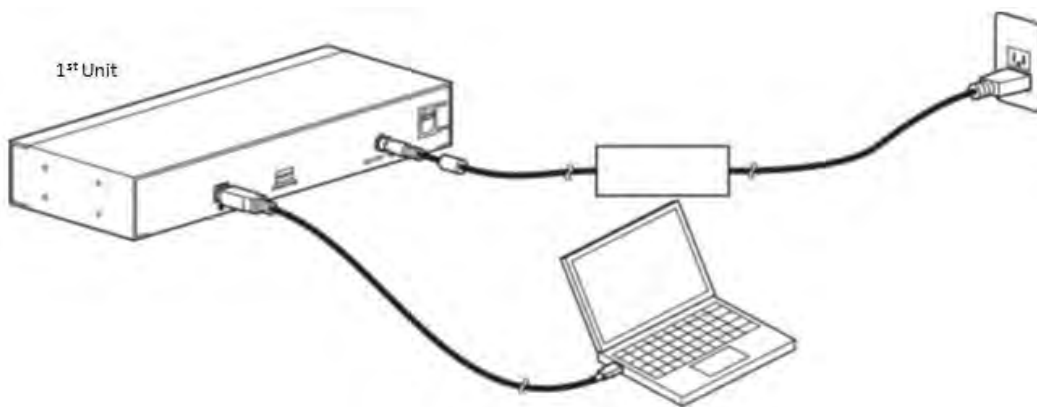

Figure 13

- 2) Turn off the power switch of the 2nd unit. **(Rear Panel)**

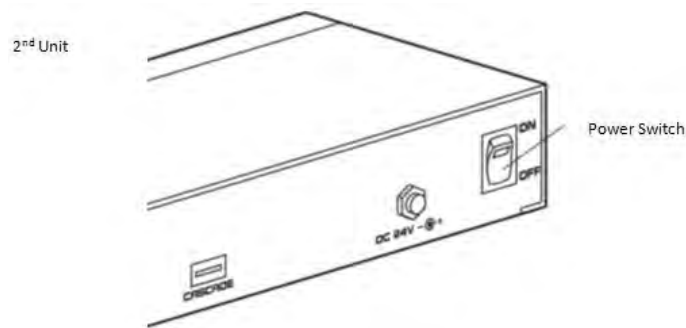

Figure 14

- 3) Plug the power adaptor to the power jack of the 2nd unit.
 - The power jack is threaded with nut, so user may fix power DC plug into the power jack without losing.
- 4) Put the plug of the power adaptor into the wall socket. **(Rear Panel)**

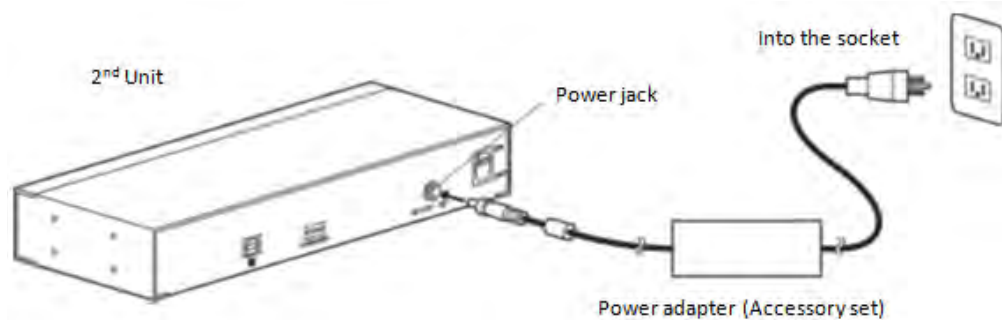

Figure 15

- 5) Turn on the power switch of the 2nd unit. **(Rear Panel)**

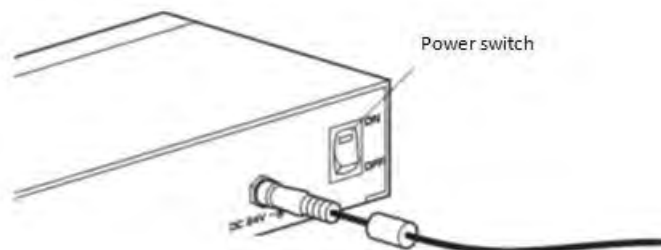

Figure 16

- 6) Use the USB cable provided and connects both USB ports of the 1st and 2nd units.

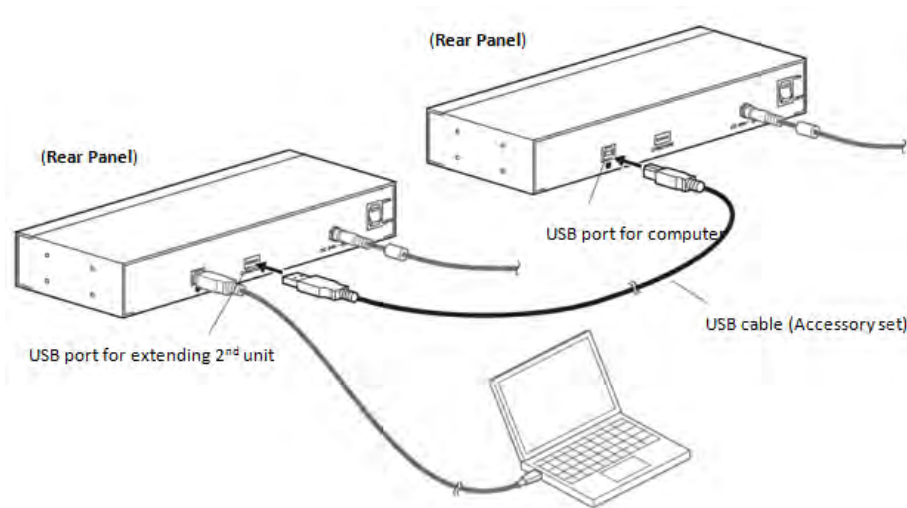

Figure 17

2.7 Regulatory Compliance

Disclaimer

Information in this document is subject to change without notice. The manufacturer does not make any representations or warranties (implied or otherwise) regarding the accuracy and completeness of this document and shall in no event be liable for any loss of profit or any other commercial damage, including but not limited to special, incidental, consequential, or other damages.

No part of this document may be reproduced or transmitted in any form by any means, electronic or mechanical, including photocopying, recording or information recording and retrieval systems without the express written permission of the manufacturer.

All brand names and product names used in this document are trademarks, or registered trademarks of their respective holders.

CE/FCC & Recycling Information

CE Certification

This equipment complies with the requirements relating to Electromagnetic Compatibility Standards EN55022/EN55024 and the further standards cited therein. It must be used with shielded cables only. It has been manufactured under the scope of RoHS compliance.

FCC Certification

This equipment has been tested and found to comply with the limits for a Class B digital device, pursuant of part 15 of the FCC Rules. These limits are designed to provide reasonable protection against harmful interference in a residential installation. You are cautioned that changes or modification not expressly approved by the party responsible for compliance could void your authority to operate equipment. This device complies with part 15 of the FCC Rules.

Operation is subject to the following two conditions:

1. This device may not cause harmful interference.
2. This device must accept any interference received, including interference that may cause undesired operation.



**WEEE (Waste of Electrical and Electronic Equipment),
Recycling of Electronic Products**

In 2006 the European Union introduced regulations (WEEE) for the collection and recycling of all waste electrical and electronic equipment. It is no longer allowable to simply throw away electrical and electronic products. More details can be obtained from your national WEEE recycling agency.



2.8 Environmental Specifications

Specification	Data
Operating Temperature:	0-70°C

3. Notes, Tips, Warnings, and Safety

Note

Note1: In order to prevent damaged data that may be caused by unsuitable operation, beware of the below issues when user is switching from sync mode to charging mode:

- User should not switch until the objective iPad or tablet OS is updated completely.
- Do not switch until the objective USB connections are removed safely from host computer.

Please check the user manual of USB devices for appropriate removing method. [Reference section 2.1](#)

Note2:

- Maximum 2 units can be connected.
- It allows connecting or changing maximum up to 10 / 20 USB devices simultaneously. [Reference section 2.6](#)

Tip

N/A

Warning

- 1) End user may extend another unit of USB 2.0 10 charge hub. (It allows connecting or charging maximum up to 10 / 20 USB devices simultaneously.)
- 2) The specific cable for iPad, tablet isn't included in package accessory. Please check with your distributor regarding of using appropriate cable.
- 3) Beware that iOS update cannot be performed simultaneously when the unit is charging for USB devices.
- 4) If user connects with two units, the 2nd unit may not be detected by some computers which have built in USB 3.0 hub.

Safety

4. Supporting References

Document	Link
Website Product Page	https://www.coolgear.com/product/usb-2-0-10-port-industrial-high-power-2-1a-charger-hub

© 2017 Coolgear, Inc. All Rights Reserved. All products and accompanying digital documentation including images are the property and / or trademarks of Coolgear Inc. Coolgear Inc. are continuously improving upon its products. Product specifications are subject to change without notice.