

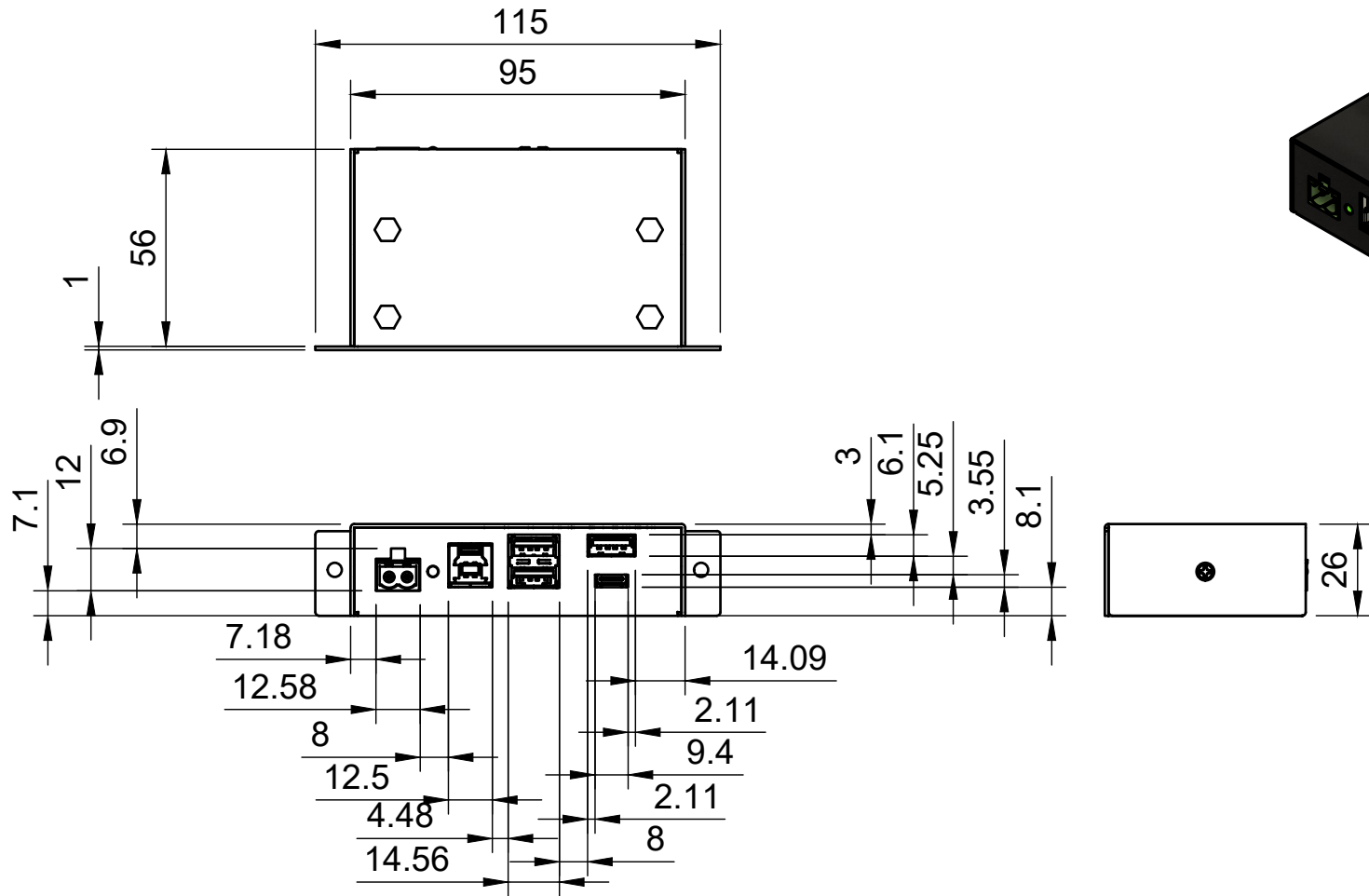



Basic Measurements  
Port Detailed Measurements

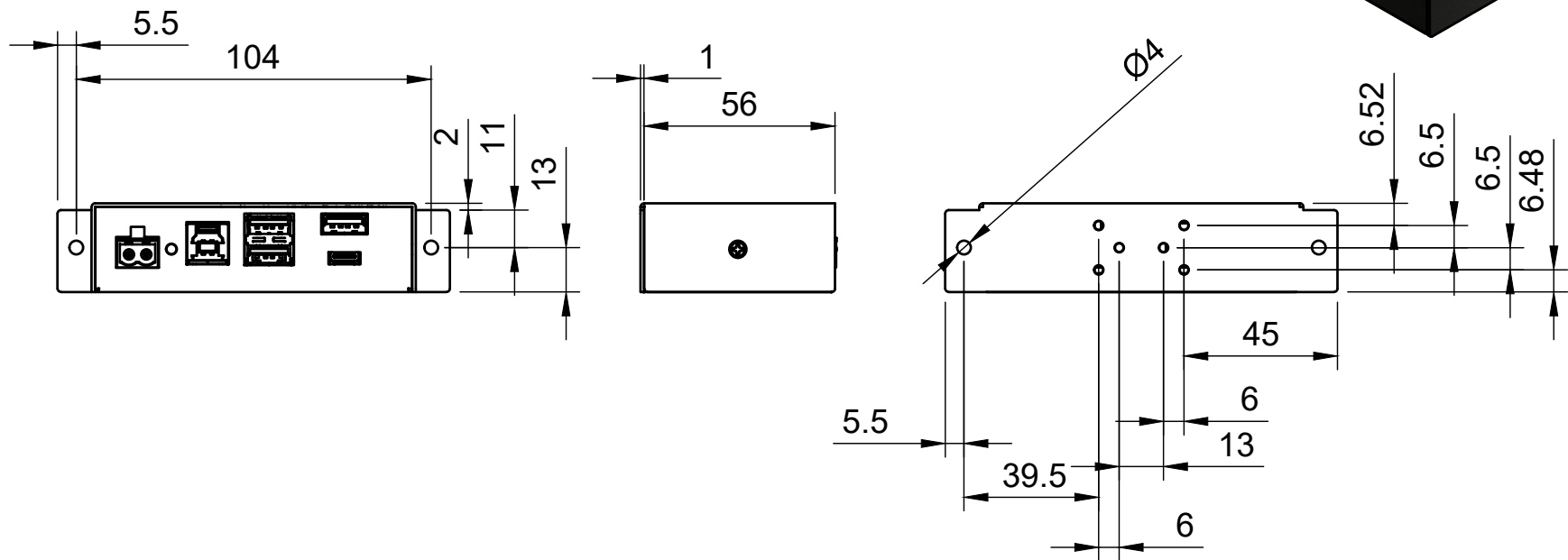

		Model #:	
		CG-4PU31C1B1	
Drawn by: Leo Pinto		Scale: 1:2	Units: mm
Drawn Date: 6/18/2021		Tolerance: +/- 0.15mm	
Notes:		Contact: support@coolgear.com	
		Web: coolgear.com	
		A4	1/3

# Mounting Holes



		Model #:	
		CG-4PU31C1B1	
Drawn by: Leo Pinto	Scale: 1:2	Units: mm	
Drawn Date: 6/18/2021	Tolerance: +/- 0.15mm		
Notes:	Contact: support@coolgear.com		
	Web: coolgear.com		
	A4	2/3	

### Accessories

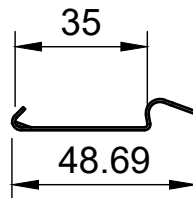
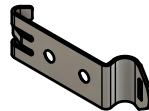
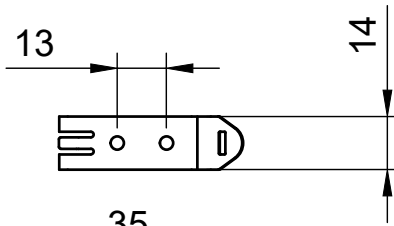
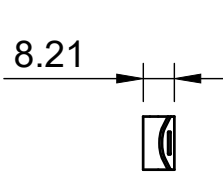
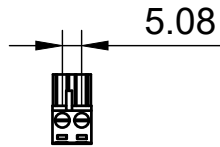
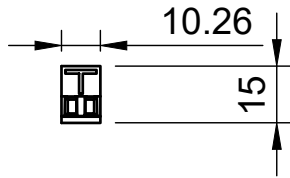
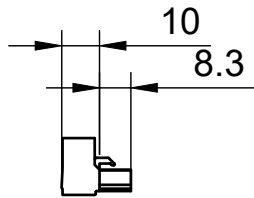

### Exploded View



		Model #:	
		CG-4PU31C1B1	
Drawn by: Leo Pinto		Scale: 1:2	Units: mm
Drawn Date: 6/18/2021		Tolerance: +/- 0.15mm	
Notes:		Contact: support@coolgear.com	
		Web: coolgear.com	
		A4	3/3