

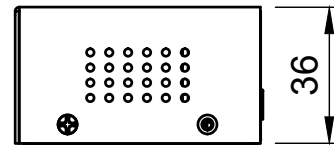

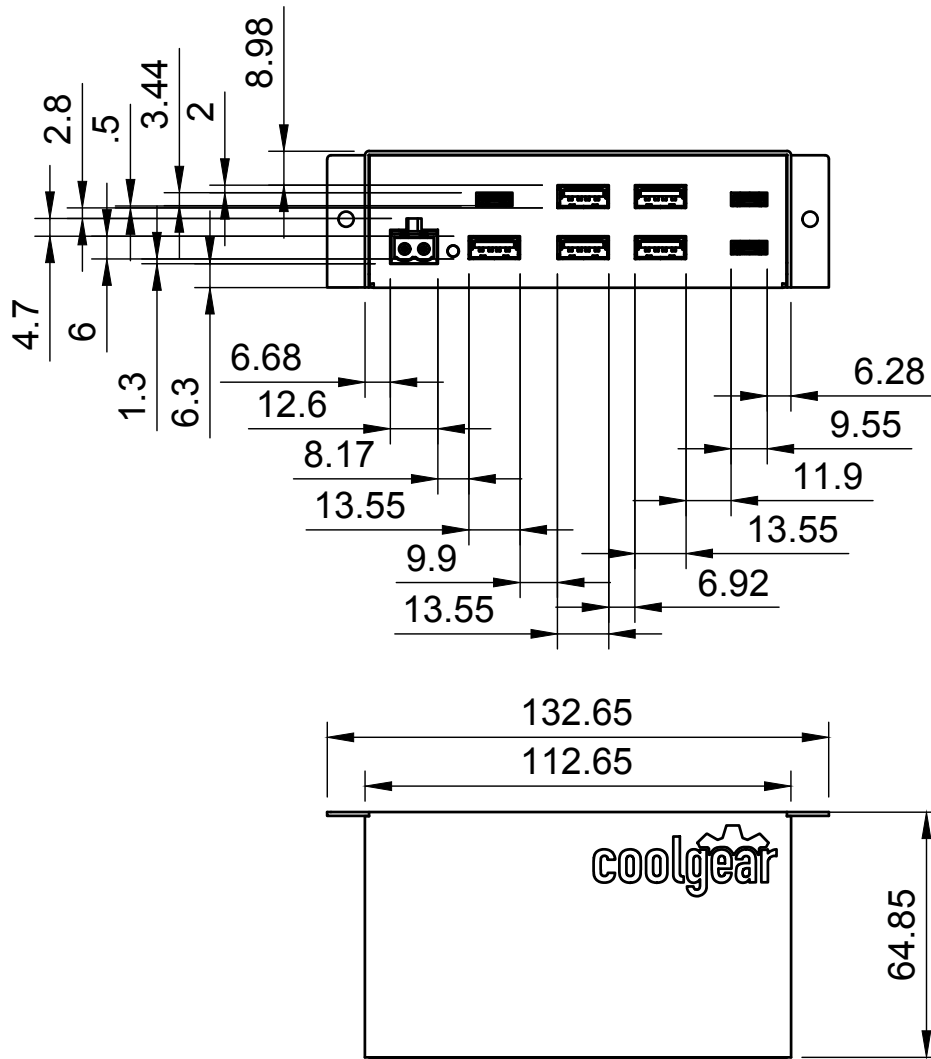

Basic Measurements

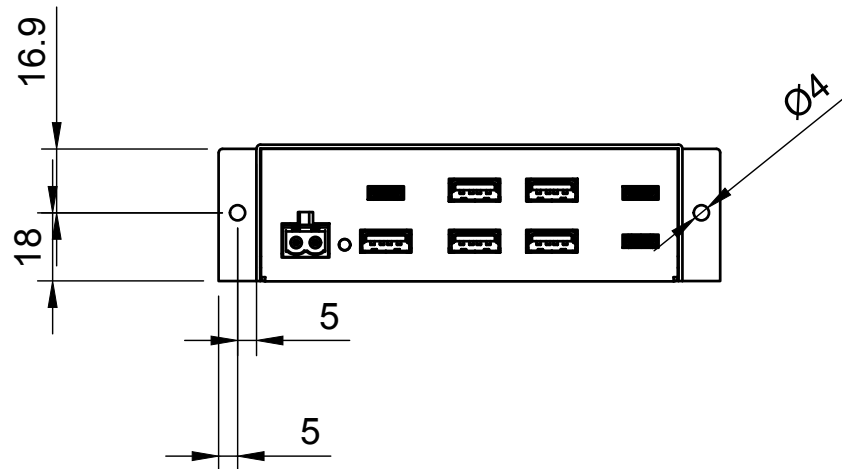
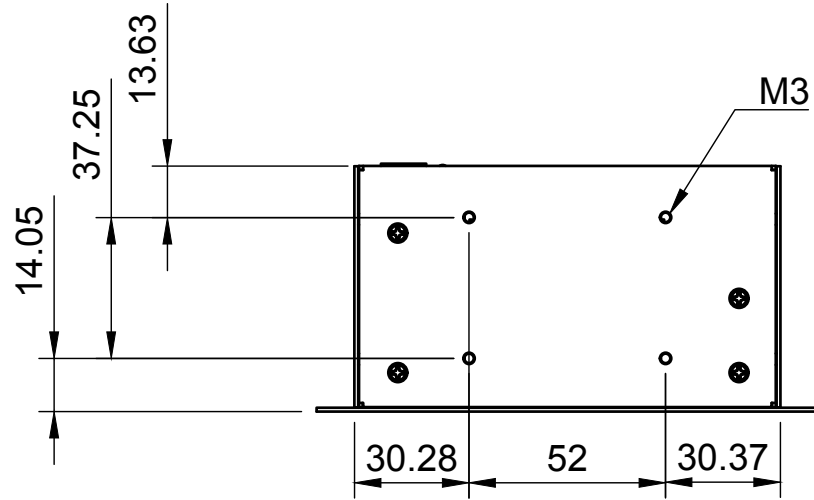

		Model #:	
		CG-7PU313C	
Drawn by: Leo Pinto	Scale: 1:2	Units: mm	
Drawn Date: 8/10/21	Tolerance: +/- 0.15mm		
Notes:	Contact: support@coolgear.com		
	Web: coolgear.com		
	A4	1/3	

Mounting Holes



		Model #:	
		CG-7PU313C	
Drawn by: Leo Pinto		Scale: 1:2	Units: mm
Drawn Date: 8/10/21		Tolerance: +/- 0.15mm	
Notes:		Contact: support@coolgear.com	
		Web: coolgear.com	
		A4	2/3

Accessories

Exploded View

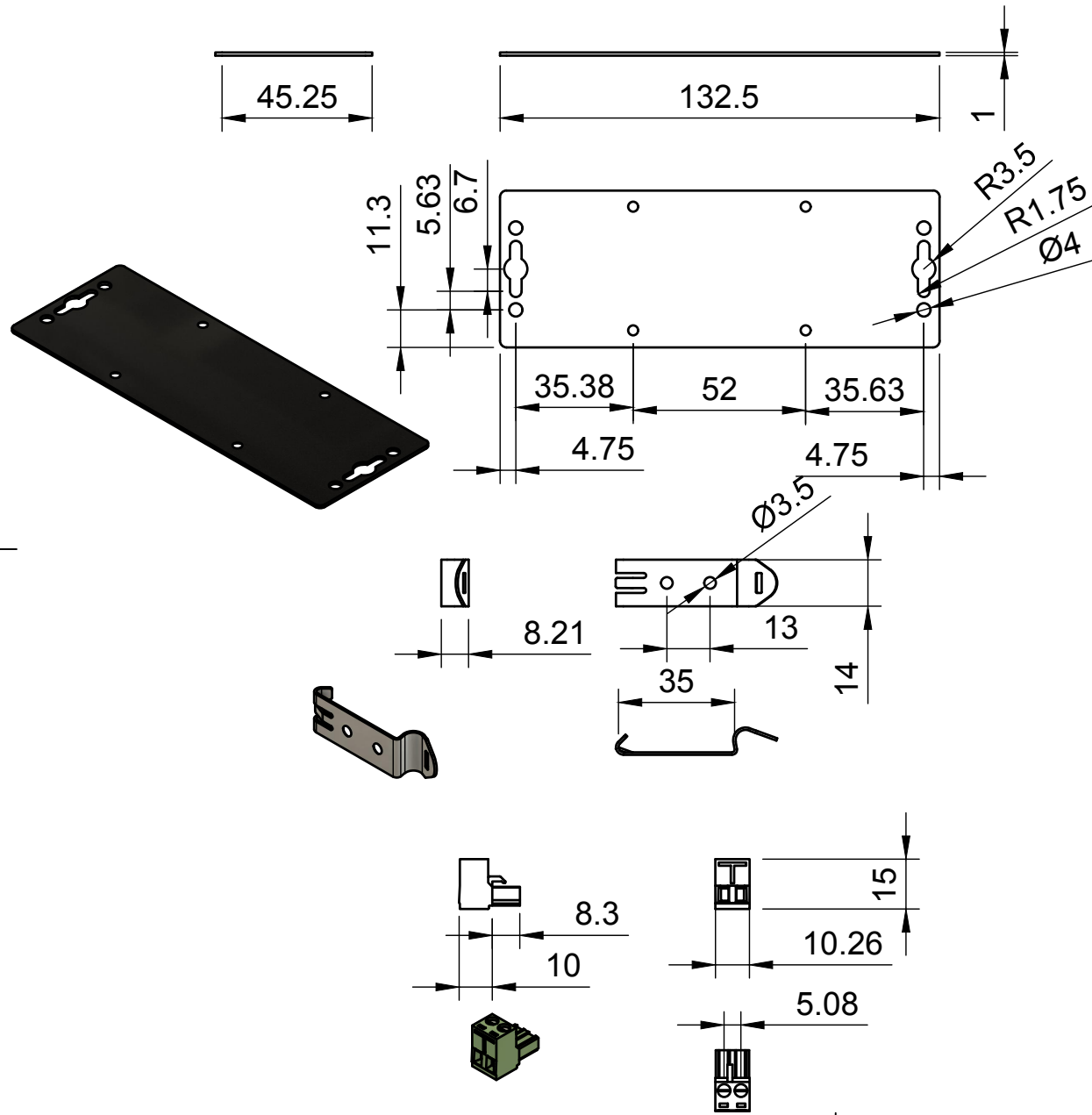

		Model #:	
		CG-7PU313C	
Drawn by: Leo Pinto	Scale: 1:2	Units: mm	
Drawn Date: 8/10/21	Tolerance: +/- 0.15mm		
Notes:	Contact: support@coolgear.com		
	Web: coolgear.com		
	A4	3/3	