

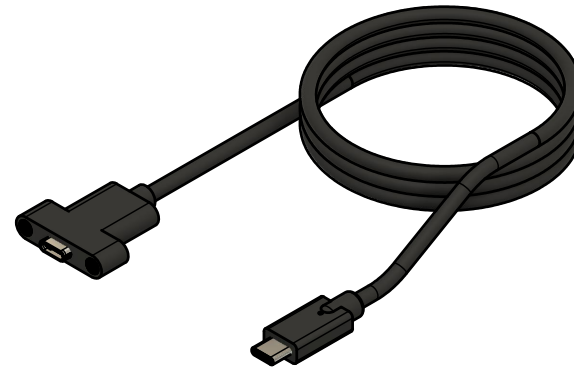

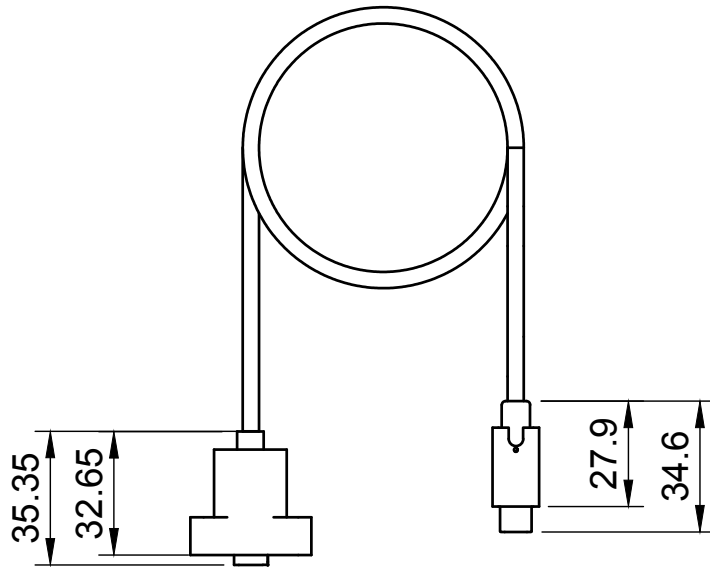

Basic Measurements
Port Detailed

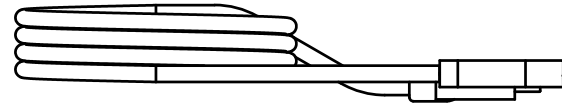
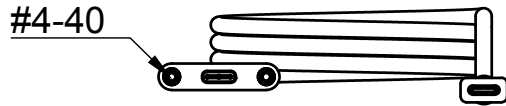

		Model #:	
		CG-U3CMCF-PM	
Drawn by: Leo Pinto	Scale: 1:2	Units: mm	
Drawn Date: 10/8/2021	Tolerance: +/- 0.15mm		
Notes:	Contact: support@coolgear.com		
	Web: coolgear.com		
	A4	1/2	

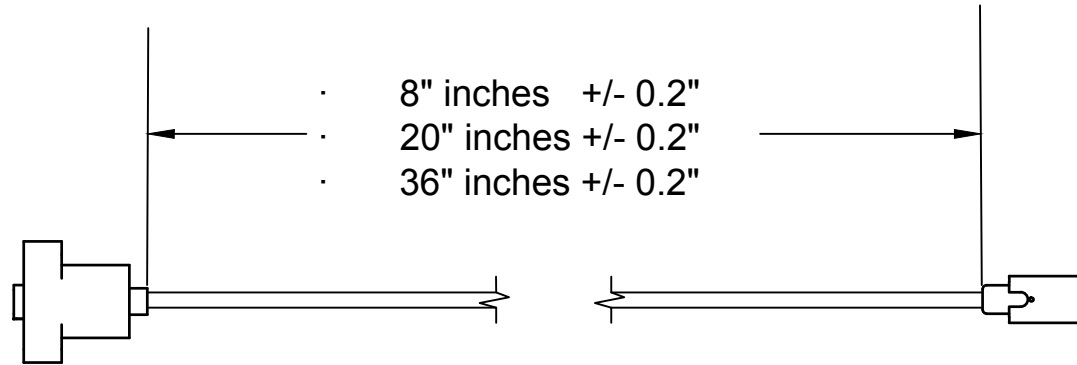
Cord Length



		Model #: CG-U3CMCF-PM	
Drawn by: Leo Pinto		Scale: 1:2	Units: mm
Drawn Date: 10/8/2021		Tolerance: +/- 0.15mm	
Notes:		Contact: support@coolgear.com	
		Web: coolgear.com	
		A4	2/2