

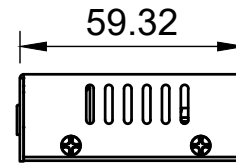

Basic Measurements  
Port Detailed

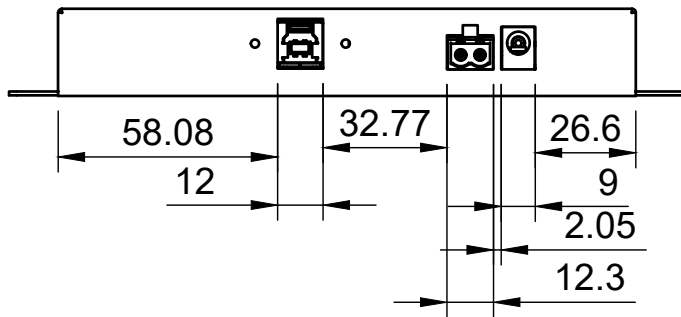

A (1:1)

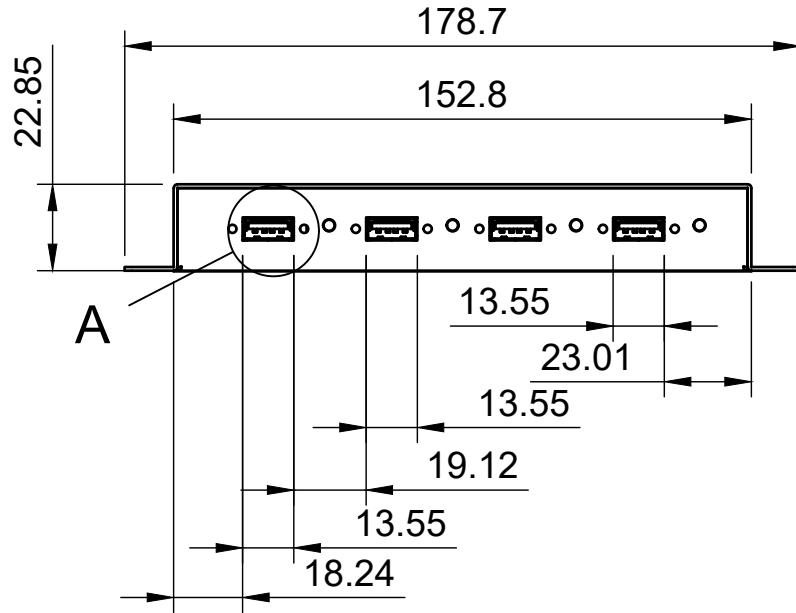
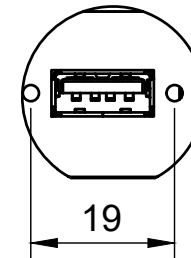

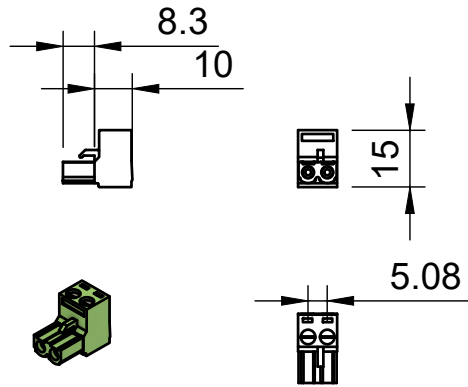

		Model #:	
		USBG-3X4Mr2	
Drawn by: Leo Pinto		Scale: 1:2	Units: mm
Drawn Date: 6/14/2021		Tolerance: +/- 0.15mm	
Notes:		Contact: support@coolgear.com	
		Web: coolgear.com	
		A4	1/2

Accessories  
Mounting Holes

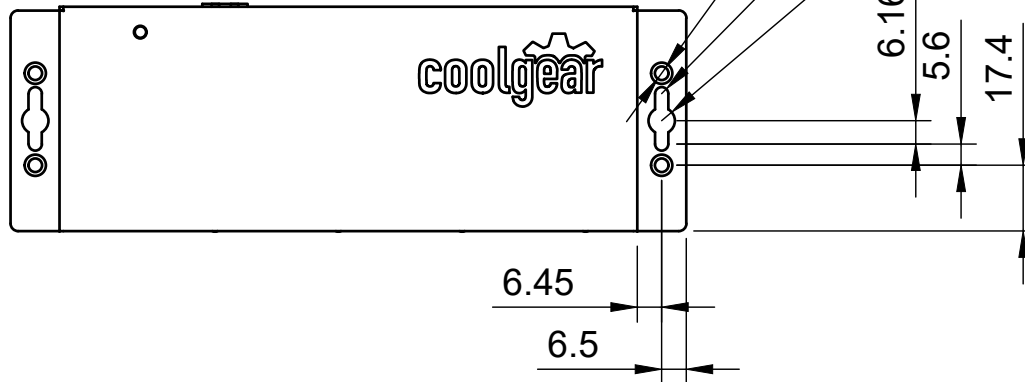

Exploded View



		Model #:	
		USBG-3X4Mr2	
Drawn by: Leo Pinto		Scale: 1:2	Units: mm
Drawn Date: 6/14/2021		Tolerance: +/- 0.15mm	
Notes:		Contact: support@coolgear.com	
		Web: coolgear.com	
		A4	2/2