

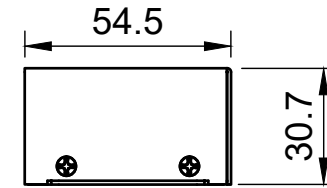

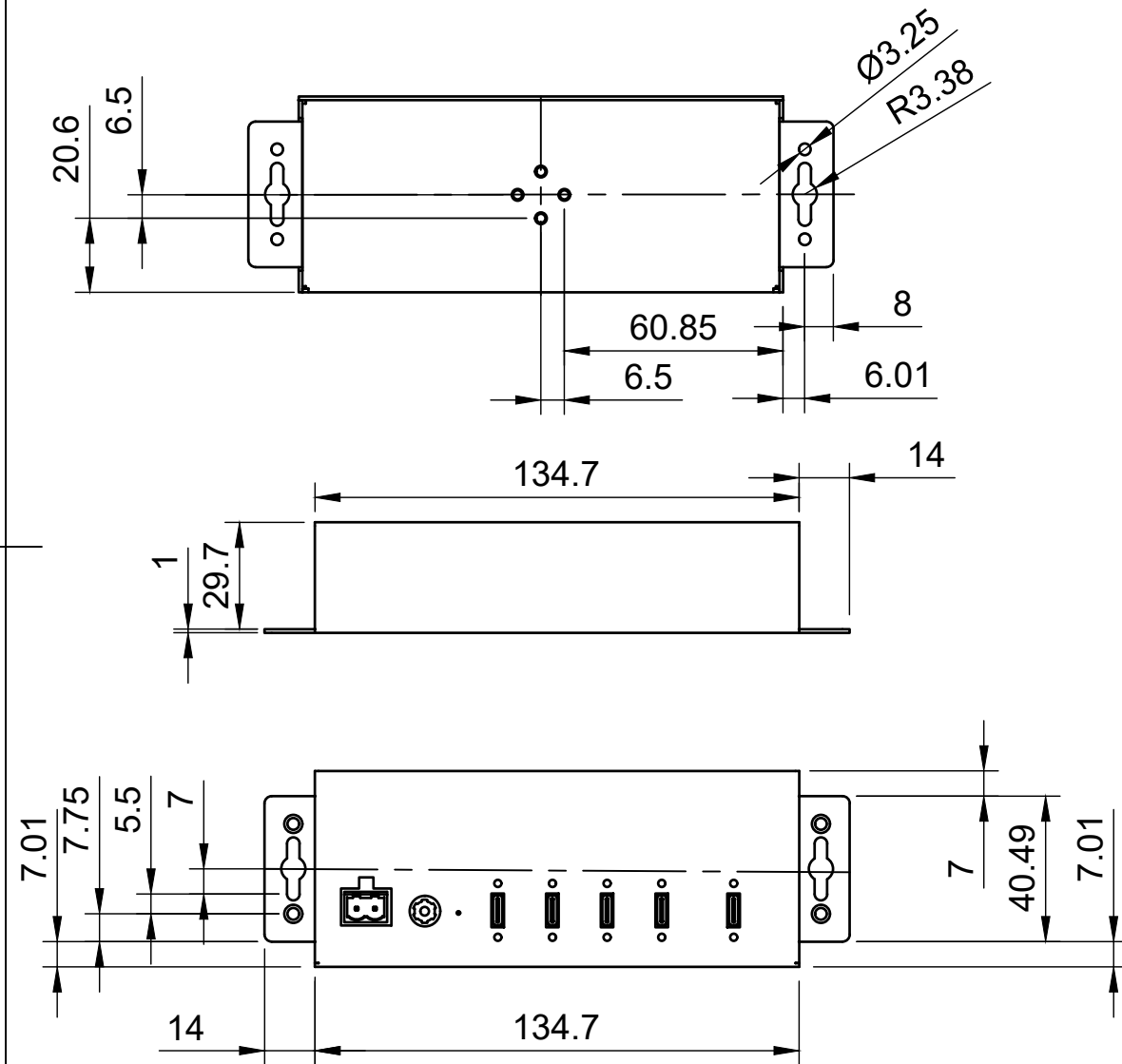

Basic Measurements
Mounting Holes

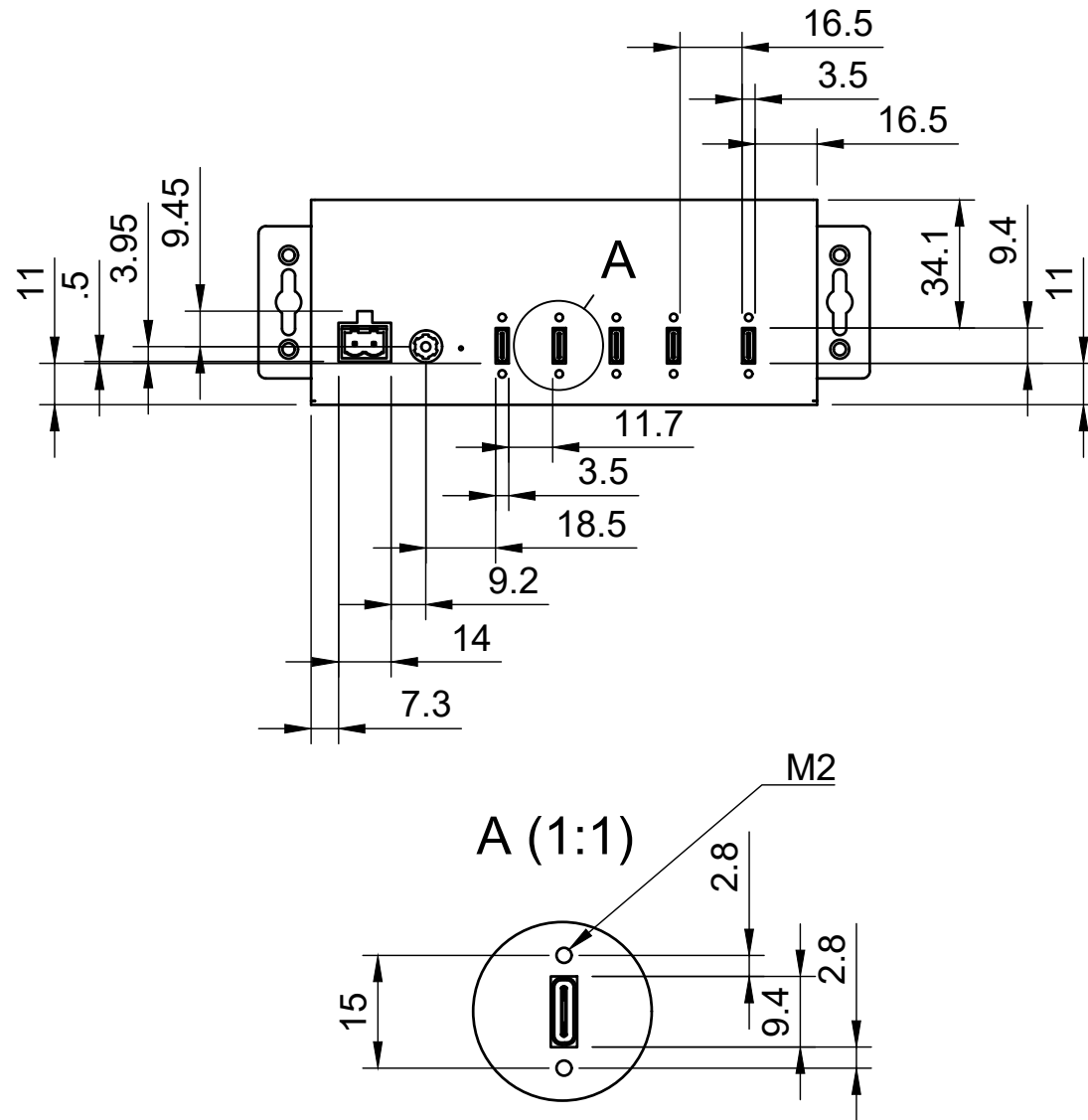

		Model #:	
		CG-4U3CML	
Drawn by: Leo Pinto		Scale: 1:2	Units: mm
Drawn Date: 3/23/2021		Tolerance: +/- 0.15mm	
Notes:		Contact: support@coolgear.com	
		Web: coolgear.com	
		A4	1/3

Detailed Port Measurements
Connector Screw Lock Holes



		Model #:	
		CG-4U3CML	
Drawn by: Leo Pinto		Scale: 1:2	Units: mm
Drawn Date: 3/23/2021		Tolerance: +/- 0.15mm	
Notes:		Contact: support@coolgear.com	
		Web: coolgear.com	
		A4	2/3

Accessories

Din Rail Mounting Clip
Phoenix Connector

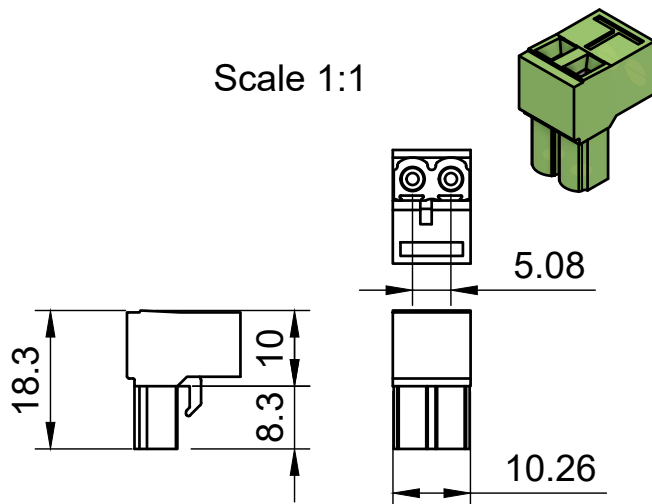
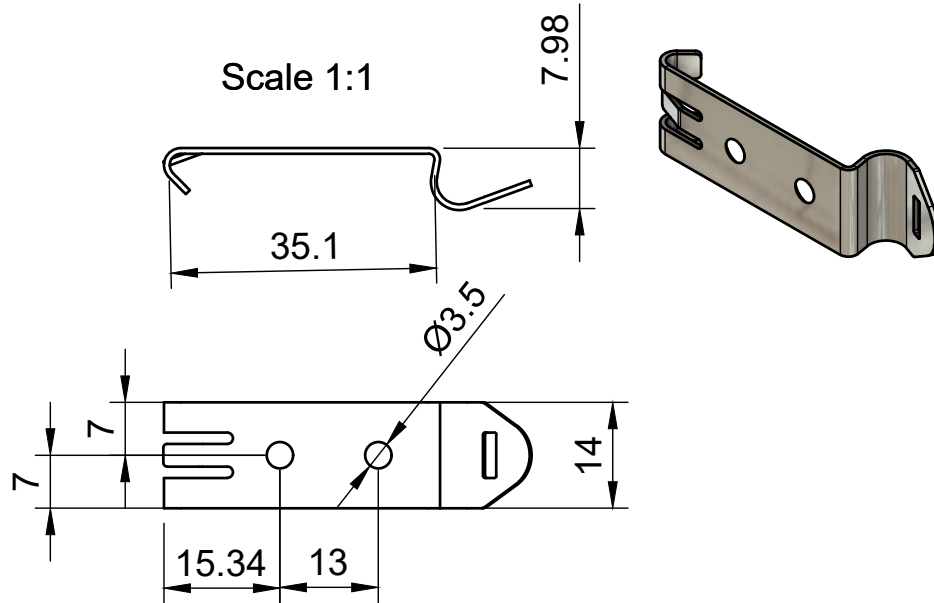

Exploded View

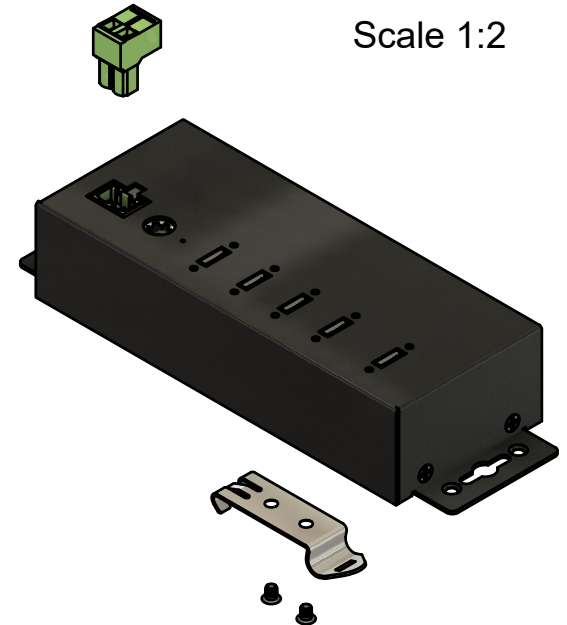

		Model #:	
		CG-4U3CML	
Drawn by: Leo Pinto		Scale: 1:5	Units: mm
Drawn Date: 3/23/2021		Tolerance: +/- 0.15mm	
Notes:		Contact: support@coolgear.com	
		Web: coolgear.com	
		A4	3/3