

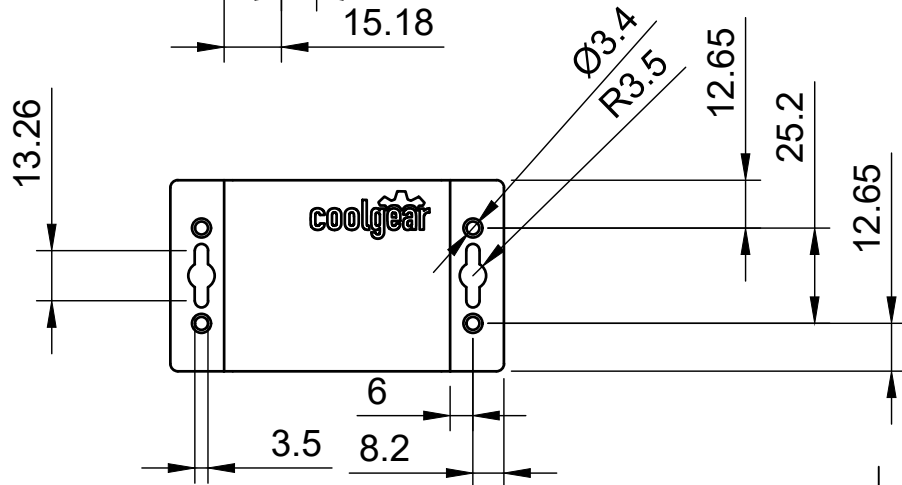

Basic Measurements
 Mounting Holes
 Detailed Port Measurements

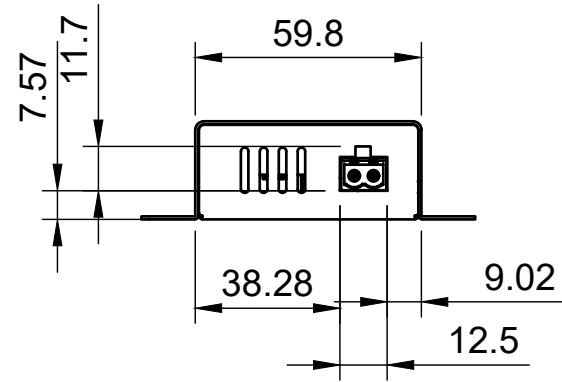

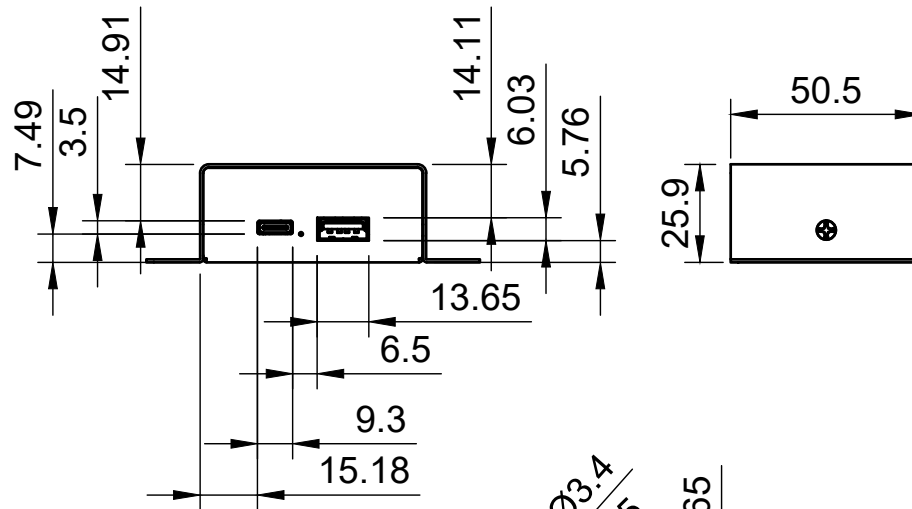
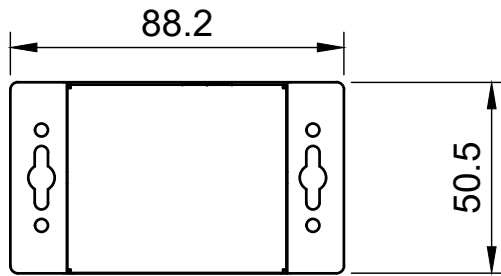

		Model #:	
		CG-PD27QC	
Drawn by: Leo Pinto		Scale: 1:2	Units: mm
Drawn Date: 3/25/2021		Tolerance: +/- 0.15mm	
Notes:		Contact: support@coolgear.com	
		Web: coolgear.com	
		A4	1/2

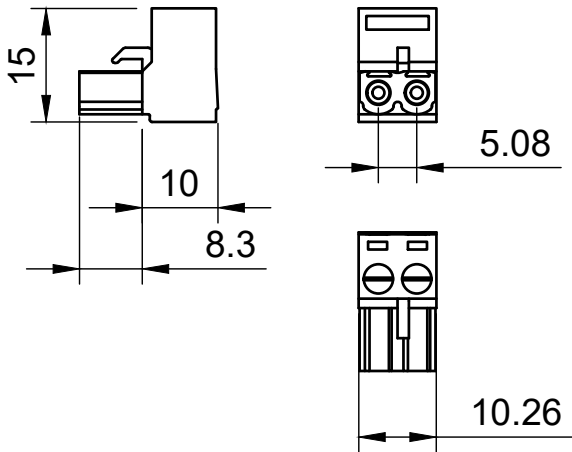
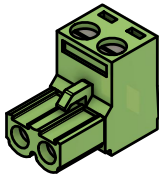
Accesories
Phoenix Connector

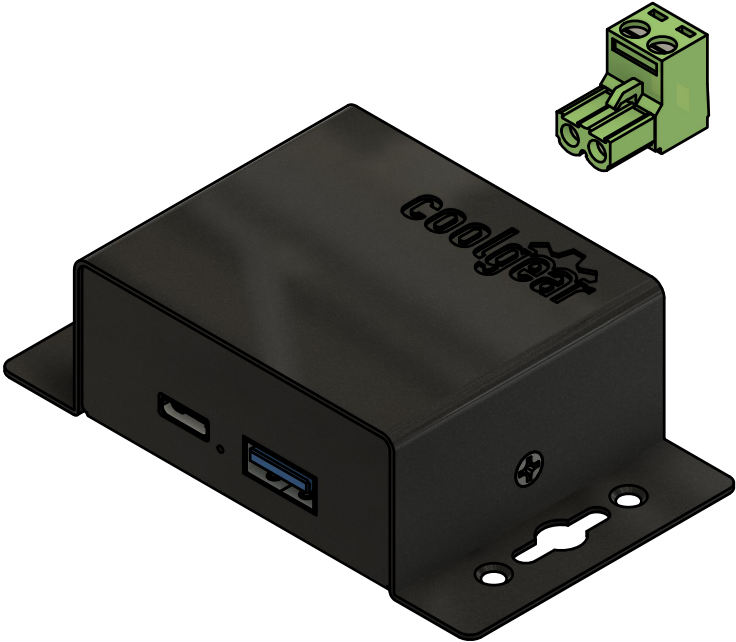

Exploded View



		Model #:	
		CG-PD27QC	
Drawn by: Leo Pinto	Scale: 1:1	Units: mm	
Drawn Date: 3/25/2021	Tolerance: +/- 0.15mm		
Notes:	Contact: support@coolgear.com		
	Web: coolgear.com		
	A4	2/2	